

Professional UHF Wireless Microphone System

VM-93C G3



Operating Instructions

G3 SERIES
Generation 3



Frequency Selectable

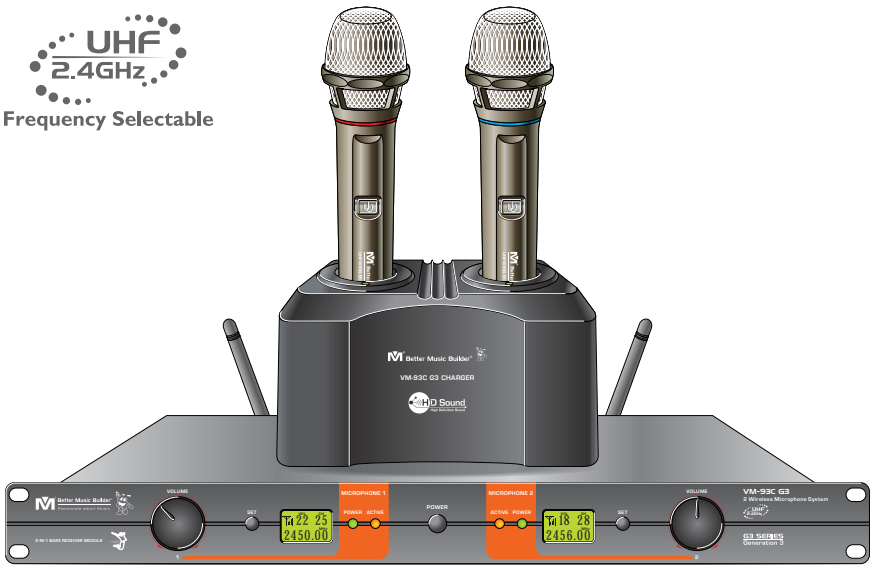

2-in-1 Base Module ***1 Receive Module with 2 Wireless Microphones System

Thank you for purchasing this unit. To make full and effective use of this unit, please read this Owner's Manual carefully before operating it. Please retain this manual for future reference.

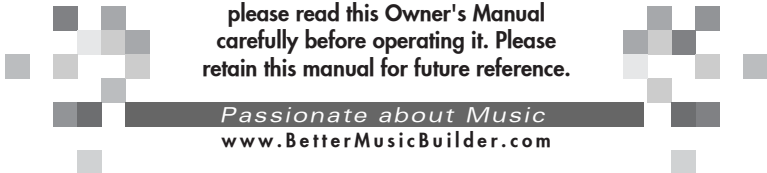

CONTENTS



INTRODUCTION..... 1



SYSTEM FEATURES..... 1



PACKAGE ACCESSORIES..... 2



2-in-1 BASE MODULE..... 3

- Controls and Functions..... 3~4
- Hardware Setup..... 5~6



HANDHELD MICROPHONE..... 7

- Controls and Functions..... 7
- Controls and Functions: Rechargeable Charger..... 7



OPERATION..... 8~10

- How to Select Frequencies/Channel..... 8~9
- How to Adjust Microphone Volume..... 10
- How to Turn On/Off Microphone..... 10
- How to Interchange Microphone Head..... 10



TECHNICAL SPECIFICATION..... 11



TROUBLESHOOTING..... 12~13



APPENDIX..... 14~15



WARRANTY..... 16



CONTACT INFORMATION..... 17



INTRODUCTION

Better Music Builder VM-93C G3 Wireless Microphone is certainly the most innovative model we've ever had! Equipped with the latest 2.4 GHz wireless technology, the sleek system features heavy duty UHF dual-channel microphones, Wireless Auto Sync System technology, and for the first time ever uses lithium-ion battery for extremely long battery life.

Built for professional entertainers, the VM-93C G3 Wireless Microphone is packed with the newest technologies and innovations to improve your performance and simplify your setup. The built-in Wireless Auto Sync System makes setting up frequencies a breeze. Using the technology, there is no need to manually adjust the microphone's frequency. With a touch of the button, the microphone automatically sets it to create a complete interference free and crystal clear microphone system.

Clear Voice technology is pure genius. It enhances the sound of the vocal by detecting and eliminating artifact noises, thus creating crystal clearer sound. The result is a sound closer resembles that of a wired microphone. What you get is a cleaner and clearer sound at all audio levels.

With years of experience designing wireless microphone system, we at Better Music Builder understand the problem with short battery life. Well, that's a thing of the past now. The VM-93C G3 Wireless Microphone can easily last 12 hours! It is our first ever wireless microphone to use rechargeable lithium-ion battery, commonly used in today's portable electronics such as mobile phones and computer laptops. It is simply the best solution for home and professional karaoke performance!



SYSTEM FEATURES

1. Equipped with the latest 2.4 GHz wireless technology and UHF dual-channel in a 2-in-1 Base Module to pick up weak signals and prevent signal interference.
2. Clear LCD screen displays Radio Frequency, Volume, Channel, and Frequency.
3. Wireless Auto Sync System technology makes setting up a breeze.
4. Clear Voice technology delivers crystal clearer sound just like a wired microphone.
5. 32 selectable channels!
6. 12 hours of battery life using rechargeable lithium-ion battery.
7. Charger base provided.
8. Adjustable antennas for better signal receiving.



PACKAGE ACCESSORIES

The package comes with one 2-in-1 Base Module [Receiver], two handheld microphones, one charge base, two receiver antennas, and two AC-Power cords.

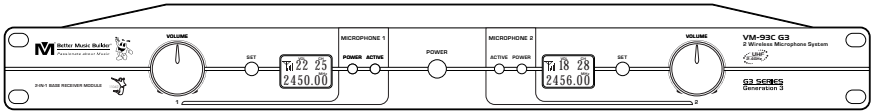

2-IN-1 BASE MODULE [RECEIVER]: 1 SET

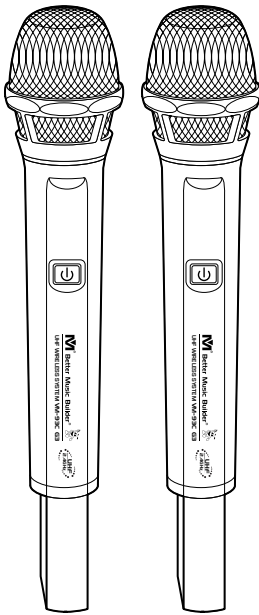

HANDHELD MICROPHONE: SET of 2

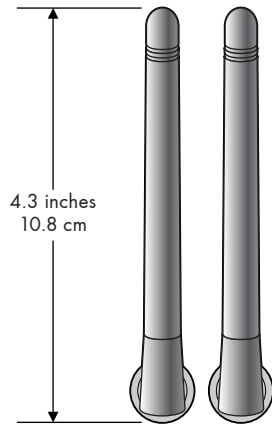

RECEIVER ANTENNA: 2 UNITS



HANDHELD MICROPHONE CHARGE BASE: 1 SET

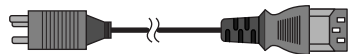

AC-POWER CORD: 2 UNITS



2-in-1 BASE MODULE [RECEIVER]

CONTROLS AND FUNCTIONS

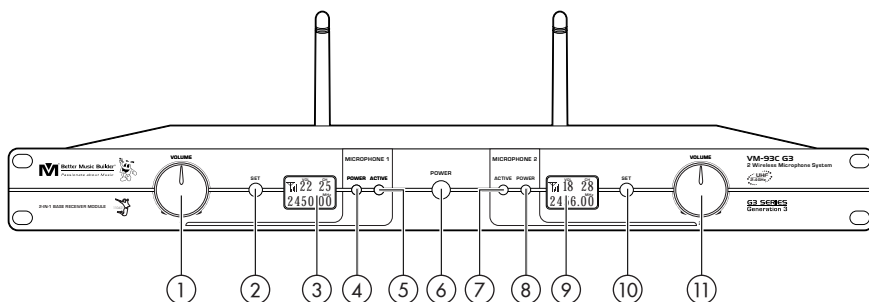

FRONT PANEL:

1. **MIC 1 VOLUME CONTROL:** Controls volume. When pressed, channel/frequency can be adjusted.
2. **MIC 1 SET BUTTON:** Confirms selection. Holding the button for 3 seconds to initiate syncing process with the microphone.
3. **MIC 1 LCD SCREEN:** Displays system status.
4. **MIC 1 POWER INDICATOR:** Lights up when the receiver is powered ON.
5. **MIC 1 ACTIVE INDICATOR:** Lights up when the microphone is ready for usage. Blinks when the receiver is in the syncing process.
6. **POWER BUTTON:** Turns the system ON/OFF.
7. **MIC 2 ACTIVE INDICATOR:** Lights up when the microphone is ready for usage. Blinks when the receiver is in the syncing process.
8. **MIC 2 POWER INDICATOR:** Lights up when the receiver is powered ON.
9. **MIC 2 LCD SCREEN:** Displays system status.
10. **MIC 2 SET BUTTON:** Confirms selection. Holding the button for 3 seconds to initiate syncing process with the microphone.
11. **MIC 2 VOLUME CONTROL:** Controls volume. When pressed, channel/frequency can be adjusted.

LCD PANEL:

After turning on the "POWER" button, LCD screen will display the following:

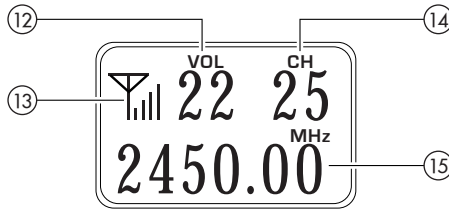

- 12. **VOLUME:** Displays the current microphone volume.
- 13. **RADIO FREQUENCY:** Strength indicator of radio signal.
- 14. **CHANNEL:** Displays the current channel.
- 15. **FREQUENCY:** Displays the current frequency.

REAR PANEL:

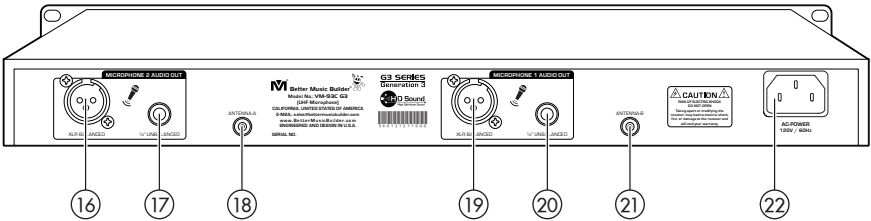

- 16. **MIC 2 BALANCED OUTPUT:** Balanced XLR audio output.
- 17. **MIC 2 UNBALANCED OUTPUT:** Unbalanced 1/4 inch audio output.
- 18. **ANTENNA-A:** Connect antenna to BNC socket here.
- 19. **MIC 1 BALANCED OUTPUT:** Balanced XLR audio output.
- 20. **MIC 1 UNBALANCED OUTPUT:** Unbalanced 1/4 inch audio output.
- 21. **ANTENNA-B:** Connect antenna to BNC socket here.
- 22. **POWER SUPPLY:** Removable AC power cord with AC 120V / 60Hz.



HARDWARE SETUP

HOW TO CONNECT AUDIO OUTPUT:

There are four audio outputs as shown in the below diagram:

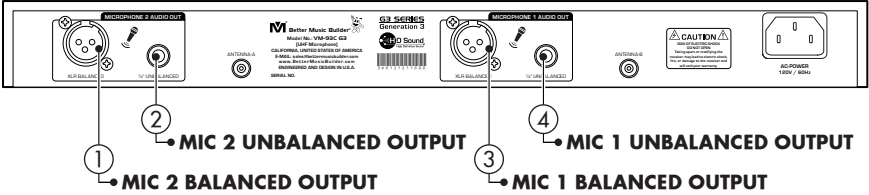

1. MIC 2 BALANCED OUTPUT is balanced audio output using XLR connection. The grounding of the balanced XLR connection delivers better quality signal by reducing noise.

2. MIC 2 UNBALANCED OUTPUT is unbalanced audio output using 1/4 inch connection.

3. MIC 1 BALANCED OUTPUT is balanced audio output using XLR connection. The grounding of the balanced XLR connection delivers better quality signal by reducing noise.

4. MIC 1 UNBALANCED OUTPUT is unbalanced audio output using 1/4 inch connection.



We highly recommend using balanced XLR connections if the distance between the microphone receiver and the mixer is more than 10 feet. The grounding of the balanced XLR connection delivers better quality signal by reducing noise.

UHF WIRELESS SYSTEM DIAGRAM:



MIC 1 HANDHELD MICROPHONE



MIC 2 HANDHELD MICROPHONE

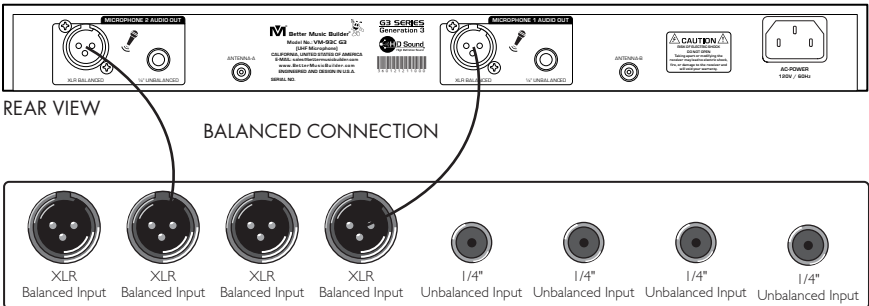

AUDIO MIXER AMPLIFIER OR A KARAOKE UNIT INPUT TERMINAL

HOW TO CONNECT AC-POWER CORD:

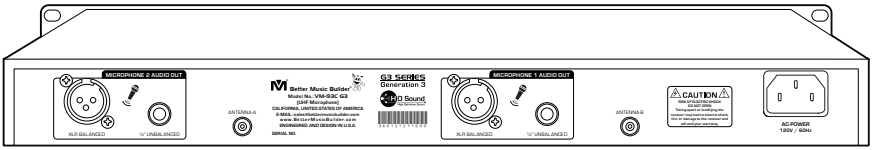

REAR VIEW

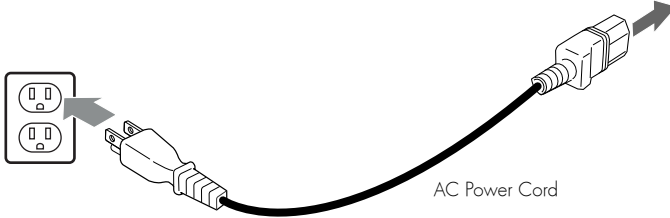

AC Power Cord

For the North America market, use AC 120V 60Hz POWER CORD. For market outside North America, use 220V~240V.

NOTE ▶ Please make sure to use the right AC Power Cord. Otherwise, it may damage the 2-in-1 Base Module or the CHARGER BASE because their maximum battery capacity is different. The product warranty will be void if there is damage caused by using the wrong AC Power Cord.



HANDHELD MICROPHONE

CONTROLS AND FUNCTIONS

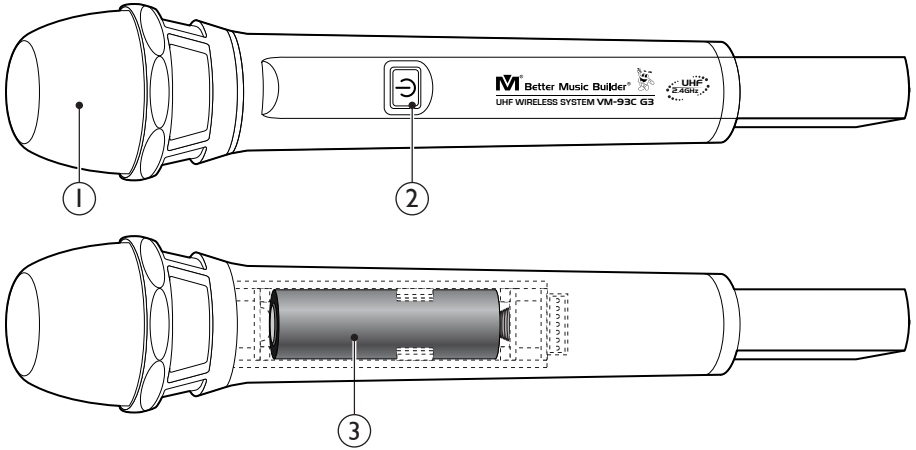

1. INTERCHANGEABLE MICROPHONE HEAD
2. POWER BUTTON: Turns the microphone ON/OFF. Holding the button for 5 seconds to initiate syncing process with the receiver.
3. LITHIUM-ION BATTERY: Unlike any other microphones in the market today, the VM-93C G3 uses lithium-ion battery (the same battery used on iPhone) for a longer battery life.

CONTROLS AND FUNCTIONS: RECHARGEABLE CHARGER

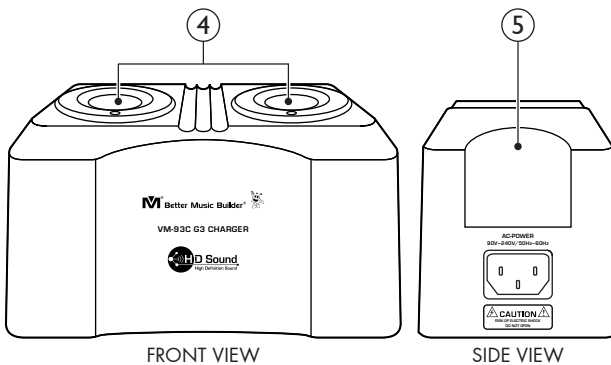

NOTE Please do not leave microphones in the CHARGER BASE longer than needed. Any misuse or damage on the battery will not be covered under our product warranty.

3. CHARGER BASE INDICATOR: Red light indicates that the battery is being charged. Green light indicates that the battery is fully charged. It takes approximately 6 hours for a full charge.
4. POWER SUPPLY: For the North America market, use POWER CORD with AC 120V 60Hz. For market outside North America, use 220V~240V.



OPERATION

HOW TO SELECT FREQUENCY/CHANNEL

Setting up the best frequency channel is quick and easy. There are two handheld microphones and each microphone is preset with 32 frequency channels.

STEP 1: Press the VOLUME CONTROL on the receiver to go to channel selection. Notice the blinking channel number.

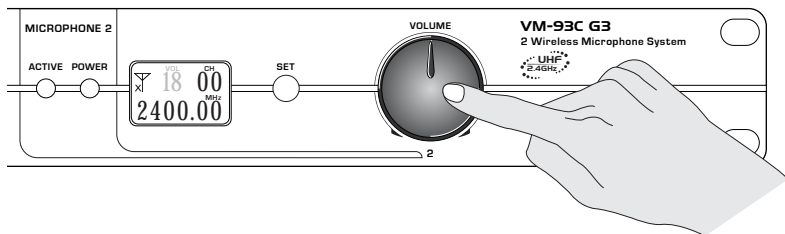

STEP 2: While the channel number is blinking, turn the VOLUME CONTROL left and right on the receiver to change the channel (32 selectable frequency channels). Then press the SET BUTTON on the receiver to confirm.

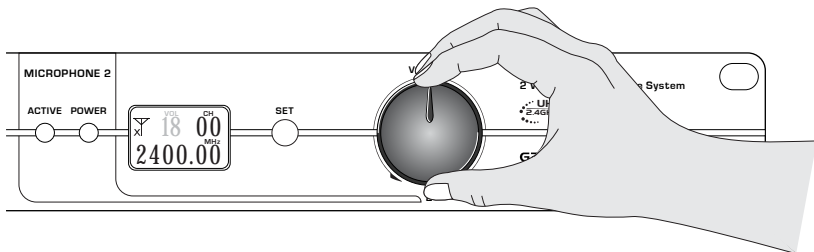

STEP 3: Press and hold the SET BUTTON on the receiver for 4 seconds to initiate the syncing process. Notice the blinking ACTIVE INDICATOR yellow light on the receiver.

4 SECONDS

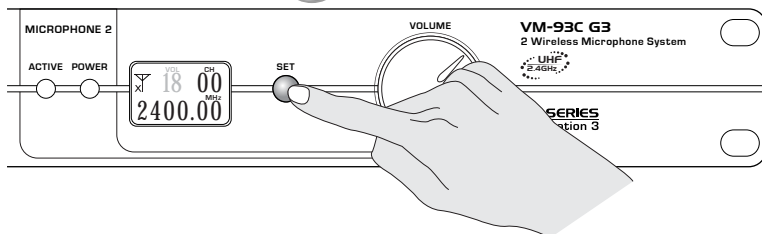

STEP 4: While the ACTIVE INDICATOR light on the receiver is blinking, turn ON the microphone and hold the POWER BUTTON on the microphone for 5 seconds to initiate the syncing process.

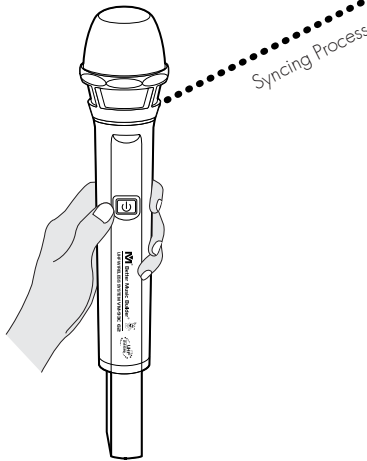
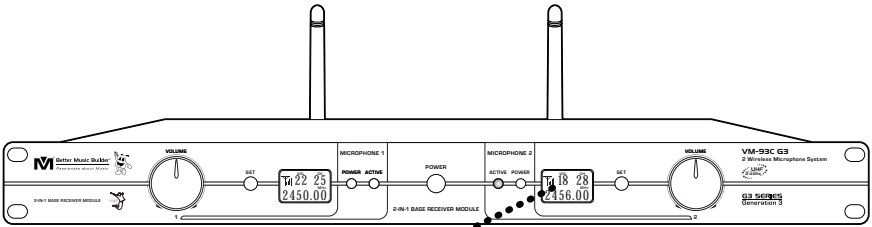

! IMPORTANT: For syncing to work, the receiver and the microphone have to initiate the syncing process at the same time. It means when holding the POWER BUTTON during STEP 4, it has to be done while the ACTIVE INDICATOR is still blinking. Otherwise, it will not work.

When the microphone is in sync with the receiver and is ready to be used, the ACTIVE INDICATOR light will be on and the RADIO FREQUENCY will display signal.

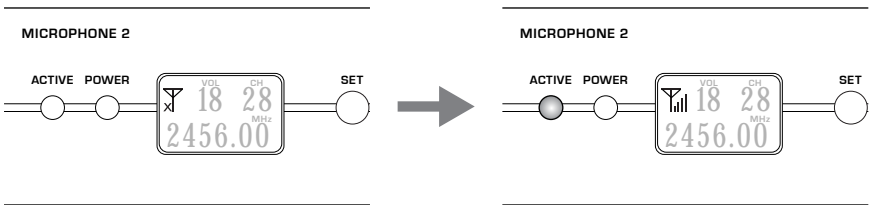

NOTE Each unit is fully tested and qualified by the manufacturer. However, due to the nature of wireless connection, interference may occur because of local environments and/or radio signals emitted by other wireless devices within the household.

If MIC 1 or MIC 2 is actively picking up RADIO FREQUENCY signal when the handheld microphone is turned off, this is an indication that the frequency is being used by some other active device within a 200 feet radius. Therefore, selecting a different frequency is highly recommended.

HOW TO ADJUST MICROPHONE VOLUME

Turn VOLUME CONTROL:

Turn LEFT to decrease the volume and Turn RIGHT to increase the volume.

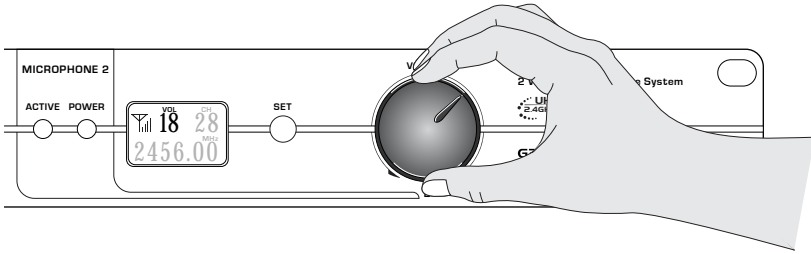

We recommend setting the microphone volume to a medium position, then control the overall volume from the amplifier/mixer.

If the user does any damage to the receiver either accidentally or intentionally, we have the right to void the warranty.

HOW TO TURN ON/OFF MICROPHONE

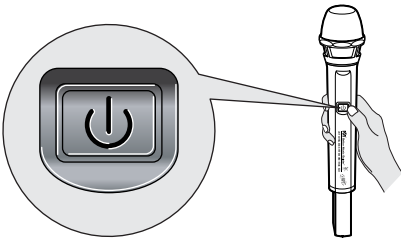

Press the POWER BUTTON to turn ON/OFF the microphone. The POWER BUTTON lights up when the microphone is ON.

NOTE ▶ If the microphone cannot be turned ON, battery may be low and should be recharged by placing the microphone onto the CHARGER BASE. Typical battery life is 12 hours. Battery life may vary depending on usage.

HOW TO INTERCHANGE MICROPHONE HEAD

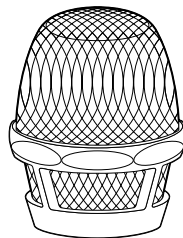
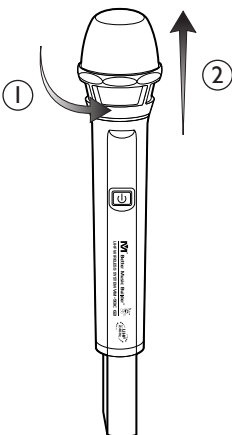

INTERCHANGEABLE
MICROPHONE HEAD

NOTE

Replacement parts such as the INTERCHANGEABLE MICROPHONE HEAD can be purchased from any of our authorized dealers.



TECHNICAL SPECIFICATION

A. TECHNICAL FEATURE OF THE 2-IN-1 BASE MODULE:

1. Frequency Range: 2400MHz~2462MHz
2. Channels: 32
3. Signal to Noise Ratio: > 95dB
4. Total Harmonic Distortion: < 0.1%
5. Frequency Response: 30Hz ~ 18kHz (± 1 dB)
6. Dynamic Range: 110dB
7. S/N Ratio: > 95dB
8. Effective Distance: 120 feet
9. Image & Spurious Rejection: > 85dB
10. Channel Rejection: > 80dB
11. Receiver Sensitivity: -85dB
12. Audio Output Level: Unbalanced Out: 0~300mV
13. Power Supply: AC 120V 60Hz
14. Receiver Dimensions (WxHxD): 19 x 1.8 x 7.5 (inches)/48.3 x 4.5 x 19 (cm)
15. Package Dimensions (WxHxD): 23.6 x 10 x 5 (inches)/60 x 25.5 x 13 (cm)
16. Shipping Weight: 8.8 lbs / 4 kg

B. TECHNICAL FEATURE OF THE MICROPHONE:

1. Transmitter Power: ≤ 20 mV
2. Max Deviation: 48kHz
3. Spurious Emission: -60dB
4. Battery: Rechargeable Lithium-ion Battery
5. Continuous Usage: Up to 12 Hours
6. Microphone Dimensions (WxH): 9.9 x 1.9 (inches) / 25.1 x 4.9 (cm)

C. THIS SYSTEM INCLUDES THE FOLLOW:

- 2-in-1 Base Module: 1 Set
- Handheld Microphone: Set of 2
- Handheld Microphone charge base: 1 Set
- Antenna: 2 Units
- AC-Power Cord: 2 Units
- Instructional Manual: 1 Unit



TROUBLESHOOTING

! CAUTION: Before troubleshooting any symptoms, make sure equipments are turned OFF.

1. SYMPTOM: NO SOUND COMING FROM MICROPHONE

CAUSE: There is no indication of signal.

REMEDIES:

- A. Battery may be low and should be recharged by placing the microphone onto the CHARGER BASE.
- B. Microphone and receiver should be in the same channel to allow transmitting and receiving signal.
- C. Volume is turned to a low level and should be turned to a high but comfortable volume level.
- D. Make sure no wires inside the microphone are loose. If so, reconnect wires if possible.
- E. Make sure the microphone is turned ON; not OFF.

2. SYMPTOM: RECEIVER LCD IS OFF.

CAUSE: Receiver is unpowered.

REMEDIES:

- A. AC POWER CORD should be connected properly.
- B. Make sure the right AC POWER CORD is being used.
- C. Determine whether there is indeed current coming from the power outlet.

3. SYMPTOM: NOISES.

CAUSE: There is interference within your area.

REMEDIES:

- A. Make sure user is not standing too close to speakers. Microphone being too close to speakers will create feedback unless microphone volume is turned down.
- B. Audio cable of poor quality should not be used. Switching to a cable of higher quality such as a balanced XLR cable can reduce noise.
- C. Switch to a model that uses a different set of channels when the above remedies do not work.

4. SYMPTOM: DISTORTION IS INCREASING GRADUALLY.

CAUSE: Battery is running low.

REMEDIES:

- A. Recharge battery as soon as possible.
- B. Make sure to fully charge battery before use.

5. SYMPTOM: POOR SIGNAL.

CAUSE: Objects can be disrupting communication between receiver and microphone.

REMEDIES:

- A. Make sure no objects are between receiver and microphone, such as walls and shelves.
- B. Make sure microphone usage is not in perimeter of police, fire or radio stations.
- C. Devices that send out radio signals can be disruptive, such as cell phones, radios, computers, etc.
- D. Switch to a model that uses a different set of channels when the above remedies do not work.



APPENDIX

VM-93C G3 FCC FREQUENCY: 2400.00~2462.00 MHz

UHF Frequencies Available for Use for Home Electronics in North America

The RF radio frequencies used in the transmission of wireless information are closely regulated in most countries including North America. A lot of countries strictly enforce their regulations stating which RF frequencies are available for use for certain device, so it can help limit the amount of radio frequency interference in all wireless communications.

Please refer to the following table for MIC 1 and MIC 2 with available RF frequencies. If the RF frequencies indicated in the following table are in conflicts with the local wireless information law in your country, please switch to a different product model or contact our technicians for advice.

FCC Information to User for Reference

This equipment is designed in compliance with the limits for a Class A digital device pursuant to part 15 of the FCC Rules from the United States of America. These limits are designed to provide protection against harmful interference when the equipment is operated in public environment. This equipment generates, uses, and can radiates radio frequency energy and, if not installed and used in accordance with the instruction manual, may cause harmful interference to radio communications. Operation of this equipment in a residential area may cause harmful interference, so the user will have to correct the interference at his/her own expense.

MIC 1 & MIC 2 FREQUENCY: 2400.00~2462.00 MHz

Microphone 1 Frequency				Microphone 2 Frequency			
CH	FREQUENCY	CH	FREQUENCY	CH	FREQUENCY	CH	FREQUENCY
0	2400.00	16	2432.00	0	2400.00	16	2432.00
1	2402.00	17	2434.00	1	2402.00	17	2434.00
2	2404.00	18	2436.00	2	2404.00	18	2436.00
3	2406.00	19	2438.00	3	2406.00	19	2438.00
4	2408.00	20	2440.00	4	2408.00	20	2440.00
5	2410.00	21	2442.00	5	2410.00	21	2442.00
6	2412.00	22	2444.00	6	2412.00	22	2444.00
7	2414.00	23	2446.00	7	2414.00	23	2446.00
8	2416.00	24	2448.00	8	2416.00	24	2448.00
9	2418.00	25	2450.00	9	2418.00	25	2450.00
10	2420.00	26	2452.00	10	2420.00	26	2452.00
11	2422.00	27	2454.00	11	2422.00	27	2454.00
12	2424.00	28	2456.00	12	2424.00	28	2456.00
13	2426.00	29	2458.00	13	2426.00	29	2458.00
14	2428.00	30	2460.00	14	2428.00	30	2460.00
15	2430.00	31	2462.00	15	2430.00	31	2462.00



WARRANTY

One-Year Limited Warranty for Home Use Equipment

Our one-year warranty applies to speakers, amplifiers, mixers and microphones for home use only. It covers both parts and labors. The warranty becomes effective on the date of your purchase.

Our warranty only covers defects due to product defectiveness with free of defects in materials or workmanship. However, our warranty does not cover defects due to normal wears, damage in transit, improper use, abuse or failure to follow the proper instructions for maintenance. This warranty is void in the event of unauthorized repairs, alternations, modifications and removing of the product label.

Please also note that our warranty does not cover any shipping cost for the return of defective products to us for inspection, repair and maintenance. Our warranty for Better Music Builder products can only be executed in North America.

NOTE ► Our warranty does not cover the battery for wireless microphone products.

90-Day Limited Warranty for Public and Commercial Use Equipment

Our 90-day warranty applies to speakers, amplifiers, mixers and microphones for both public and commercial use such as restaurant, coffee shop, KTV nightclub, church and school, etc. It covers both parts and labors. The warranty becomes effective on the date of your purchase.

To Register Your Warranty

Please submit the warranty card that comes with your unit; it is also download on our website . However, we need the invoice for your purchase in order to process this warranty. You may also register your warranty online.

Please visit our website at www.BetterMusicBuilder.com.

PRECAUTION

1. If using more than one microphone system, please select the operating frequency or signal channel carefully so as to avoid disturbing.
2. The input power voltage of the 2-in-1 Base Module is 110V/120V ($\pm 10\%$). If it is too low or too high, it will affect the work of the machine.
3. When installing batteries, reversing the electrode will damage the machine.



Caution: To reduce the risk of electrical shock, do not remove the cover (or back). No user serviceable parts inside: refer servicing to qualified personnel.

Warning: To reduce the risk of fire or electrical shock, do not expose this appliance to rain or moisture.



This symbol, wherever it appears, alerts you to the presence of uninsulated dangerous voltage inside the enclosure voltage that may be sufficient to constitute a risk of shock.



This symbol, wherever it appears, alerts you to important operating and maintenance instructions in the accompanying literature. Read the manual.



CONTACT INFORMATION

MAILING ADDRESS



BETTER MUSIC BUILDER
29300 Kohoutek Way #150
Union City, CA 94587
U.S.A.

TELEPHONE NUMBERS



USA Region
USA Toll Free: 1-800-318-2218
Sales & Marketing: 510-477-9955
Customer Service: 510-477-9955

FAX NUMBERS



USA Region
Sales & Marketing: 510-477-9922
Customer Service: 510-477-9922

WORLD WIDE WEB



E-mail: sales@bettermusicbuilder.com
Website: www.bettermusicbuilder.com

Better Music Builder® is a leader in the Audio and Karaoke equipment industry. We are committed to offering you high quality audio products. Unlike any others brand, we deliver the best cost and value to you directly. For the latest update information including operation manuals, installation instructions, hook-up diagram and other new technologies updates etc. please visit us at our website www.BetterMusicBuilder.com.



Passionate about Music
www.BetterMusicBuilder.com



Code: 20121128