

## Professional UHF Wireless Microphone System

# VM-92U G2



## Operating Instructions



Frequency Selectable



2-in-1 Base Module \*\*\*1 Receive Module with 2 Wireless Microphones System

Thank you for purchasing this unit. To make full and effective use of this unit, please read this Owner's Manual carefully before operating it. Please retain this manual for future reference.

# CONTENTS



**INTRODUCTION..... 1**



**SYSTEM FEATURES..... 1**



**PACKAGE ACCESSORIES..... 2**



**2-in-1 BASE MODULE..... 3**

- Controls and Functions..... 3~4
- Hardware Setup..... 5~6



**HANDHELD MICROPHONE..... 7**

- Controls and Functions..... 7~8



**OPERATION..... 9~13**

- How to Select Frequencies for the Receiver..... 9
- How to Match Receiver's Frequency with Microphone..... 10
- How to Select Frequency/Channel for the Receiver..... 11
- How to Adjust Squelch..... 11
- How to Insert/change Batteries of Microphone..... 12
- How to Turn On/Off Microphone..... 13
- How to Interchange Microphone Head..... 13



**TECHNICAL SPECIFICATION..... 14**



**BODY-PACK MICROPHONE (Optional)..... 15~16**



**TROUBLESHOOTING..... 17~18**



**APPENDIX..... 19~21**



**WARRANTY..... 22**



**CONTACT INFORMATION..... 23**



## INTRODUCTION

Better Music Builder VM-92U G2 is a second generation wireless microphone that uses the latest UHF wireless technology. It is a heavy duty design which includes two hand-held microphones with one 2-in-1 Base Module, built-in LCD panel on both microphones and base units, solid built aluminum alloy handles, and Wireless Infrared Auto Sync System.

The exceptional use of dual 2-in-1 Base Module allows for the use of two channels to be on at one time improves signal quality and noise interference prevention. Each hand-held microphone has 100 selectable channels. The two microphones together have a total of 200 channels in the 725.000 MHz to 774.750 MHz frequency range, which are authorized for UHF home use in the United States by FCC.

The G2 Series built in dual LCD panels allowing user to actively monitor the status of the system channel selections and microphone battery levels with clear status RF (Radio Frequency) connection and sensitive AF (Audio Frequency) input signal indicators. The super bright backlight LCD allows user to dim light setting, in turn, giving the owner full control and maintenance of the microphone system day and nights.

It comes with easy and convenient portable mounting rack for rental system usage, making this system a perfect use by Professional DJ and System Rental, KTV clubs, restaurants, coffee shops and churches, etc.



## SYSTEM FEATURES

1. Equipped with the latest wireless technology and UHF dual-channel in a 2-in-1 Base Module to pick up weak signals and prevent signal interference.
2. Clear LCD screen displays Radio Frequency, Volume, Channel, and Frequency.
3. Wireless Auto Sync System technology makes setting up a breeze.
4. Clear Voice technology delivers crystal clearer sound just like a wired microphone.
5. 100 selectable channels!
6. Adjustable antennas for better signal receiving.
7. AA batteries for easy usage.
8. Left / Right squelch knobs.



## PACKAGE ACCESSORIES

The package comes with one 2-in-1 Base Module [Receiver], two handheld microphones, two receiver antennas, one DC adaptor, one unbalance audio cable, and four AA batteries.

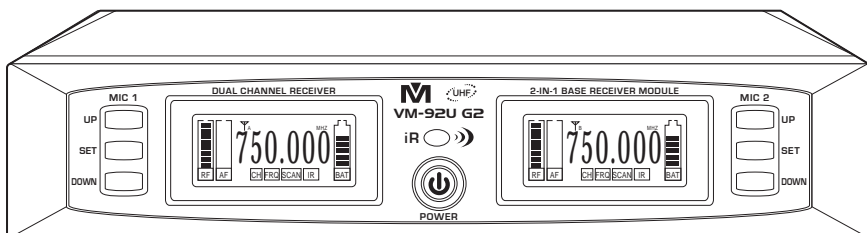

2-IN-1 BASE MODULE [RECEIVER]: 1 SET

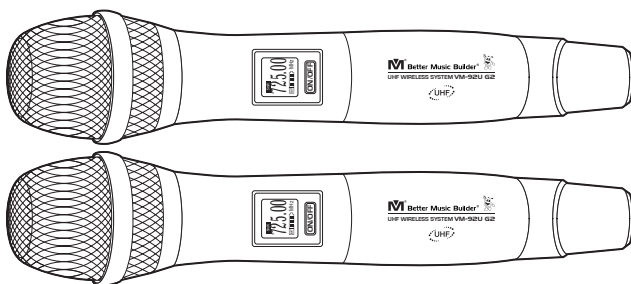

HANDHELD MICROPHONE: SET of 2

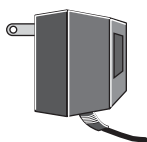

DC POWER ADAPTOR: 1 UNIT

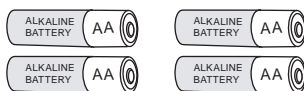

AA (1.5V) BATTERY: 4 UNITS

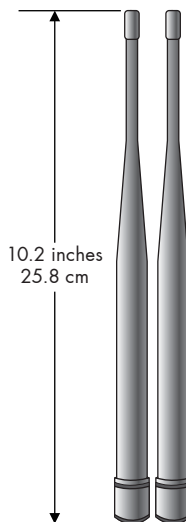

RECEIVER ANTENNA: 2 UNITS

**NOTE** ► DC-POWER USAGE: This wireless microphone system is designed specifically for the North American market, which uses 120V for DC power. For usage in Asia or Europe, please change it to 220V by an adaptor with DC 14V output 500mA.

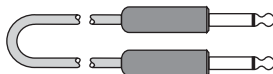

AUDIO CABLE (FOR MIXED OUTPUT): 1 UNIT



For better quality connections, a XLR to XLR cable is highly recommended.



## 2-in-1 BASE MODULE [RECEIVER]

### CONTROLS AND FUNCTIONS

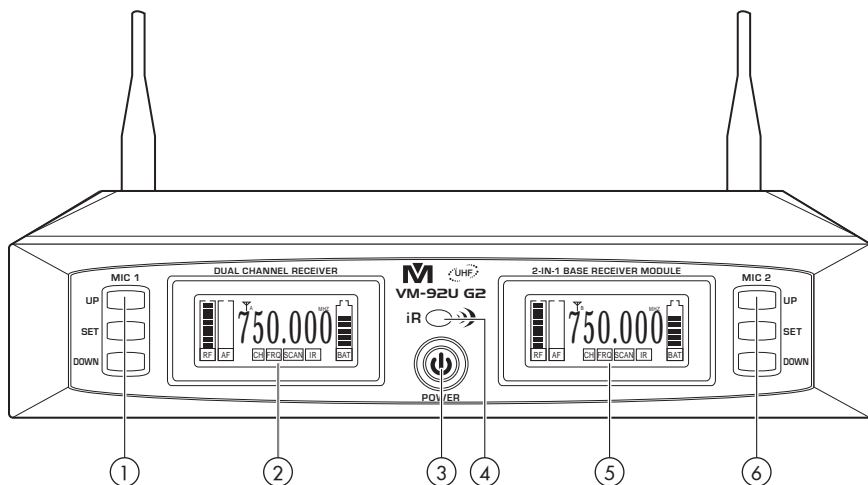

#### FRONT PANEL:

1. **MIC 1 SELECTOR BUTTONS (UP/SET/DOWN):** Allows control of LCD screen and it's functions
2. **MIC 1 LCD SCREEN:** Displays MIC 1 system status.
3. **POWER BUTTON:** Turns the system on/off.
4. **IR PORT:** Infrared port for the Wireless Infrared Auto Sync System. Pointing the handheld microphone's infrared port at the receiver's infrared port to allow communication.
5. **MIC 2 LCD SCREEN:** Displays MIC 2 system status.
6. **MIC 1 SELECTOR BUTTONS (UP/SET/DOWN):** Allows control of LCD screen and it's functions

## LCD PANEL:

After turning on the “POWER” button, LCD screen will display the following:

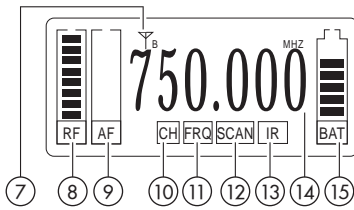

7. Antenna A/B: Displays the antenna in use.
8. Radio Frequency: Strength indicator of radio signal.
9. Audio Frequency: Strength indicator of incoming audio signal.
10. Channel & Select: Displays current channel & Selector for channel.
11. Frequency Select: Selects frequency.
12. Scan: Scans for microphone frequency.
13. Infrared Scan: Scans for microphone Infrared frequency.
14. Frequency: Displays current frequency.
15. Battery Status: Displays microphone battery status.

## REAR PANEL:

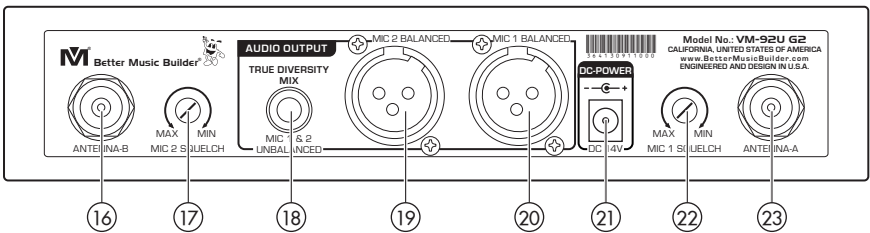

16. ANTENNA-B: Connect the antennas to the BNC socket.
17. MIC 2 SQUELCH CONTROL: Distance coverage adjustment.
18. MIXED OUTPUT: unbalanced 1/4" audio output for MIC 1 & MIC 2.
19. MIC 2 BALANCED OUTPUT: balanced XLR audio output.
20. MIC 1 BALANCED OUTPUT: balanced XLR audio output.
21. POWER SUPPLY: Removable adapter with DC14~22V 500mA.
22. MIC 1 SQUELCH CONTROL: Distance coverage adjustment.
23. ANTENNA-A: Connect the antennas to the BNC socket.



# HARDWARE SETUP

## HOW TO CONNECT AUDIO OUTPUT:

There are three rear outputs as shown in the below diagram:

**MIXED OUTPUT** is unbalanced audio output for MIC 1 & MIC 2 using 1/4" connection. When using this output, MIC 1 and MIC 2 have to share a signal. To produce different effects on each microphone, MIC 1 and MIC 2 need their own signals which can be done by using XLR connections.

**MIC 1 BALANCED OUTPUT** is balanced audio output for MIC 1 using XLR connection. When using this output, you can change MIC 1 effects without affecting MIC 2 effects.

**MIC 2 BALANCED OUTPUT** is balanced audio output for MIC 2 using XLR connection. When using this output, you can change MIC 2 effects without affecting MIC 1 effects.



We highly recommend using balanced XLR connections if the distance between the microphone receiver and the mixer is more than 10 feet. The grounding of the balanced XLR connection delivers better quality signal by reducing noise.

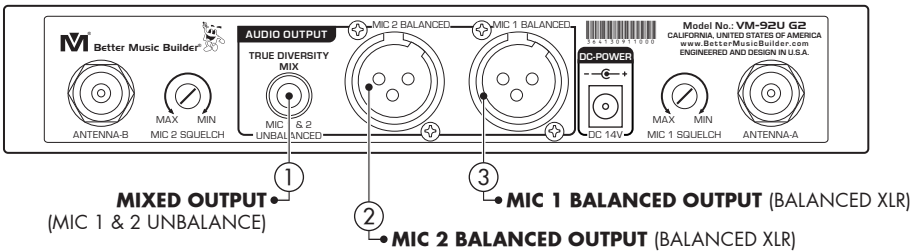

## UHF WIRELESS SYSTEM DIAGRAM:



MIC 1 HANDHELD MICROPHONE

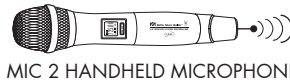

MIC 2 HANDHELD MICROPHONE

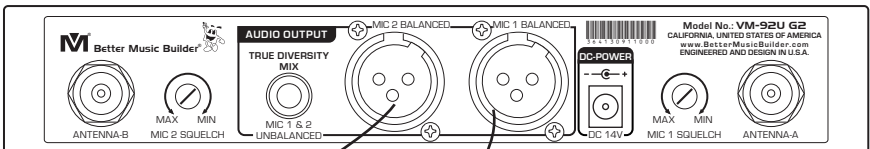

REAR VIEW

BALANCED CONNECTION

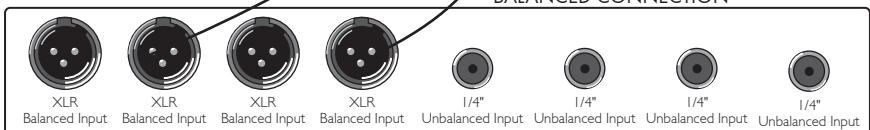

AUDIO MIXER AMPLIFIER OR A KARAOKE UNIT INPUT TERMINAL

## HOW TO CONNECT DC-POWER:

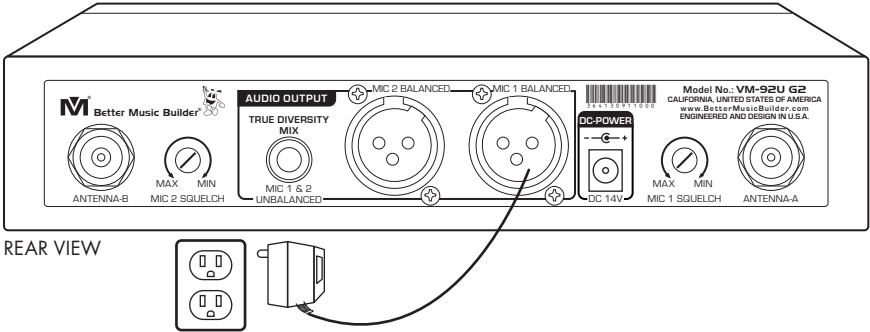

For North America Market, use 120V, DC 14~22V 500mA adaptor. For market outside North America, use 220V~ 240V DC adaptor with a maximum battery capacity of 500mA.

**NOTE** ▶ Please make sure to use the right DC adaptor. Otherwise, it may damage the 2-in-1 Base Module and the charger because their maximum battery capacity is different. The product warranty will be voided if there is damage caused by using the wrong DC adaptor.

## OPTIONAL 19" RACK MOUNT KIT:

To put the system onto a mount-kit, please follow the diagram below. Our special design feature allow it to be mounted on a DJ rack.

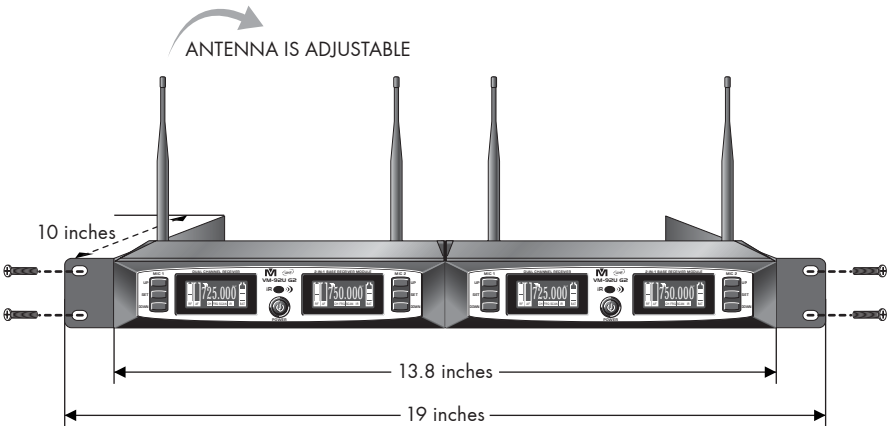

Rack mount kit is not included in package.

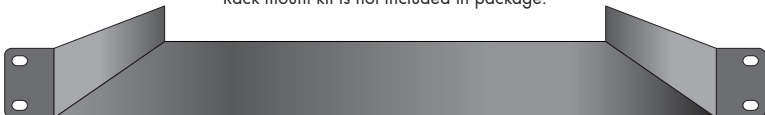





# HANDHELD MICROPHONE

## CONTROLS AND FUNCTIONS

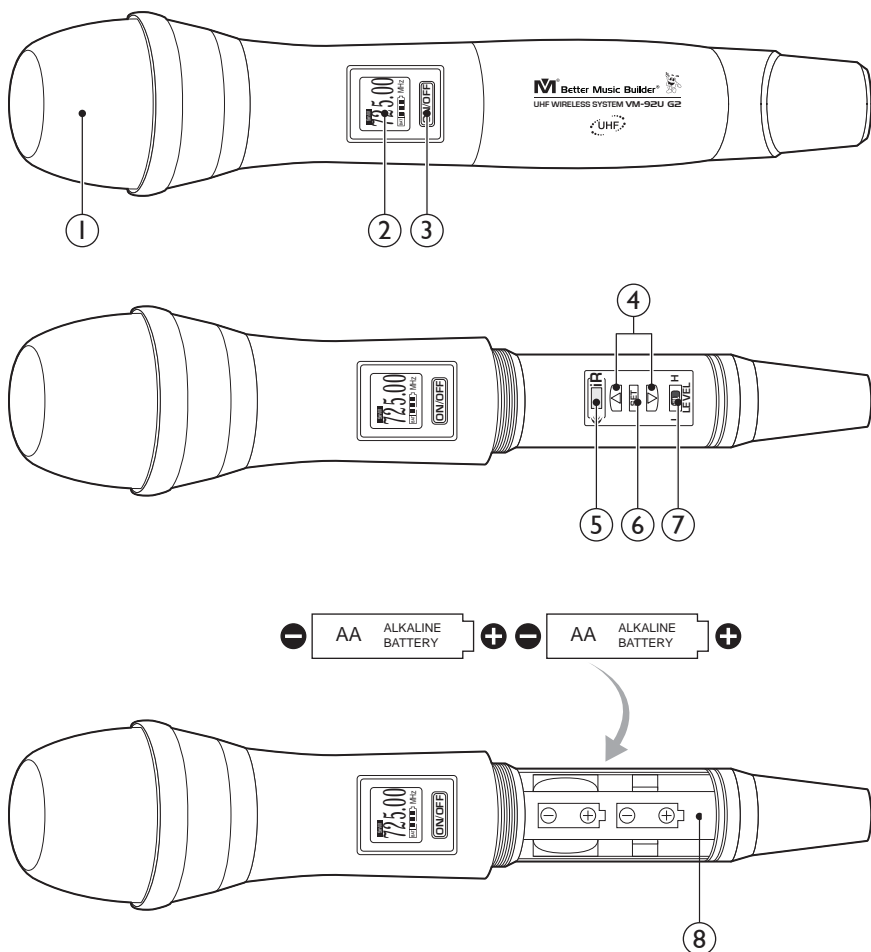

1. INTERCHANGEABLE MICROPHONE HEAD
2. LCD DIGITAL DISPLAY
3. POWER ON/OFF BUTTON
4. FREQUENCY SELECTION BUTTON: Press UP/DOWN button to select frequency.
5. IR PORT: Infrared port for the Wireless Infrared Auto Sync Technology. Point the microphone's infrared port at the receiver's infrared port to allow communication.
6. SET BUTTON: Press SET button to confirm frequency.
7. TRANSMISSION POWER LEVEL CONTROLLER
8. BATTERY SLOTS: Insert 2x1.5V AA battery or 2x1.2V rechargeable battery.

## LCD PANEL:

After turning on the "POWER", the LCD screen will light up as below:

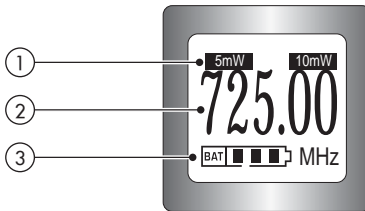

1. **RADIO FREQUENCY SIGNAL:** Switch to High (10mW) to use a stronger signal and Low (5mW) to use a weaker signal.
2. **FREQUENCY:** Current value depends on your setting.
3. **BATTERY STATUS:** Indicates battery life.

## BATTERY STATUS:

Full Battery

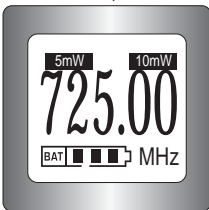

Indicates full battery on the microphone. The engineering team of Better Music Builder uses the latest technology to indicate the battery status, so you can see the battery strength.

Low Battery

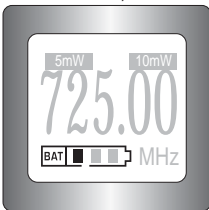

Indicates low battery on the microphone. When the microphone LCD screen is blinking or fading, its time to replace the batteries.

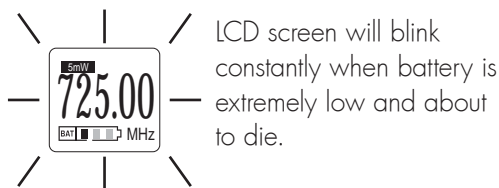

LCD screen will blink constantly when battery is extremely low and about to die.

**NOTE** ▶ If the microphone cannot be turned on, please check the battery. It may be very low. Typical new full battery life is 4~6 hours with our system, otherwise, the batteries might be defective or near expiration date.

Batteries are not covered under our product warranty.



## OPERATION

### HOW TO SELECT FREQUENCIES FOR THE RECEIVER

The 2-in-1 Base Module comes with two handheld microphones and the microphones are preset with 100 frequency channels. The frequency can be selected either automatically or manually.

#### 1. AUTOMATIC FREQUENCY SELECT

**STEP 1:** Press “SET” on the receiver to allow the “CH” text to blink.

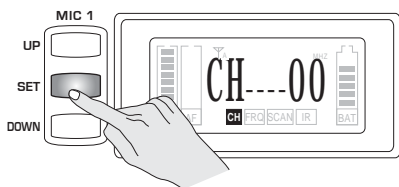

**STEP 2:** Press “UP” or “DOWN” until “SCAN” is blinking and press “SET”. This will allow the receiver search for the strongest frequency to set.

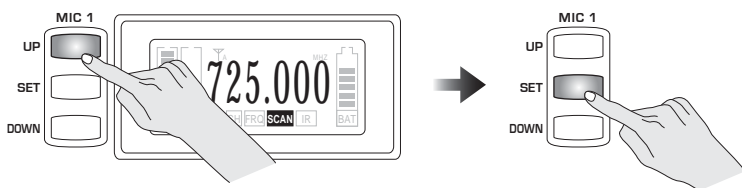

#### 2. MANUAL FREQUENCY SELECT

**STEP 1:** Press “SET” on the receiver to allow the “CH” text to blink.

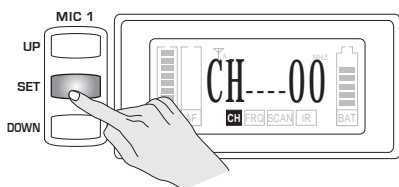

**STEP 2:** Press “UP” or “DOWN” until “FRQ” is blinking and press “SET”. While flashing, select the desired frequency. Once selected, wait until FRQ stops flashing.

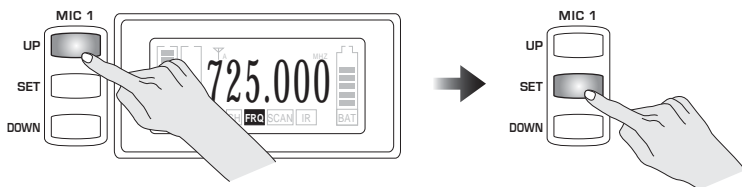

# HOW TO MATCH RECEIVER'S FREQUENCY WITH MICROPHONE

**STEP 1:** Press "SET" on the receiver to allow the "CH" text to blink.

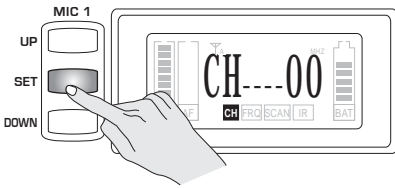

**STEP 2:** Press "UP" or "DOWN" until "IR" is blinking and press "SET".

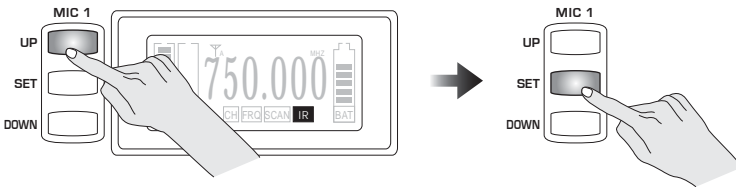

**STEP 3:** While the "IR" light is on, turn ON the microphone, open battery compartment and point the microphone infrared port (IR) directly at the receiver's IR PORT to initiate the syncing process.

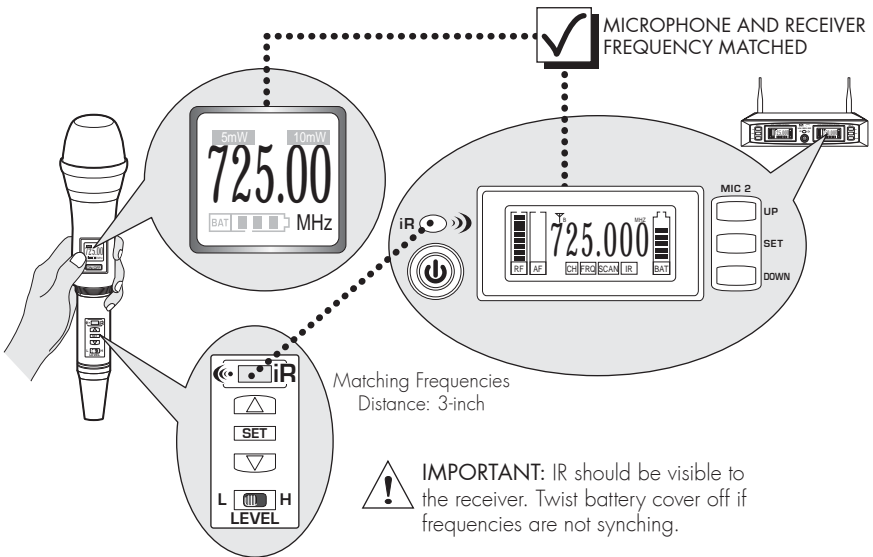

**NOTE** ▶ Please make sure that the other handheld microphone is turned off when adjusting the frequency on one microphone.

Each unit is fully tested and qualified by the manufacturer. However, due to the nature of wireless connection, interference may occur because of local environments and/or radio signals emitted by other wireless devices within the household.

## HOW TO SELECT FREQUENCY/CHANNEL FOR THE RECEIVER

Frequencies can be recorded by finding the channel of the frequency. To do so;

**STEP 1:** Press "SET" on the receiver to allow the "CH" text to blink. Once blinking press "SET" again, the frequency's channel will be displayed on a range of 0~99.

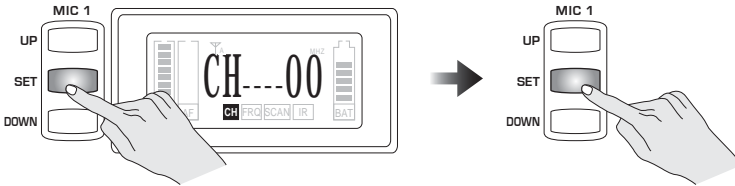

**NOTE** ▶ If you need to find a channel for a frequency not selected, please follow steps for "Manual Frequency Select" then follow step 1 for ".:Frequency/Channel Select").

## HOW TO ADJUST SQUELCH

The SQUELCH knob on the back of the receiver adjusts the distance range between the microphone and the receiver. Use a plastic screwdriver to make the squelch adjustment at the button. A higher level of squelch allows the usage of microphone further away from the receiver. However, the drawback of using a higher level of squelch is the increased chance of interference.

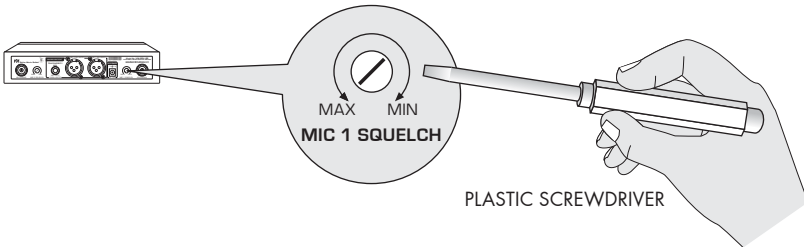

# HOW TO INSERT/CHANGE BATTERIES OF MICROPHONE

**STEP 1:** Twist open battery cover.

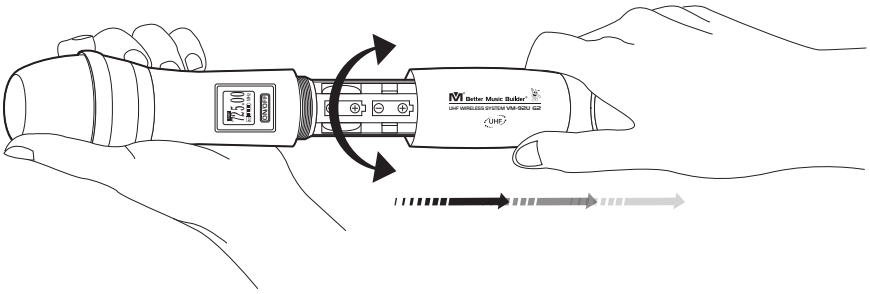

**STEP 2:** Use one hand to hold onto the top of the Microphone, and the other hand to slide 2x1.5V AA batteries into battery slot. Be careful not to drop Microphone while inserting batteries.

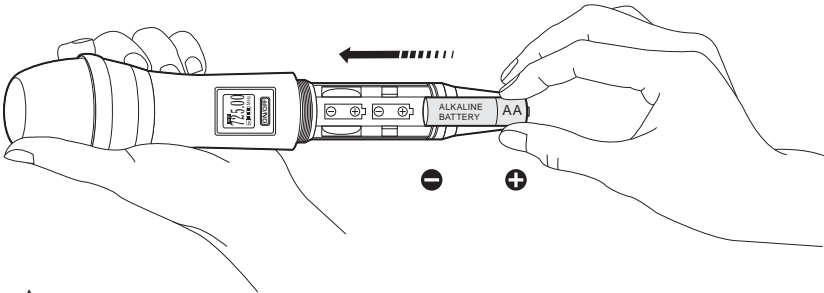

 Make sure to follow the polarity of the battery according to the battery slots.



**STEP 3:** Twist back battery cover.

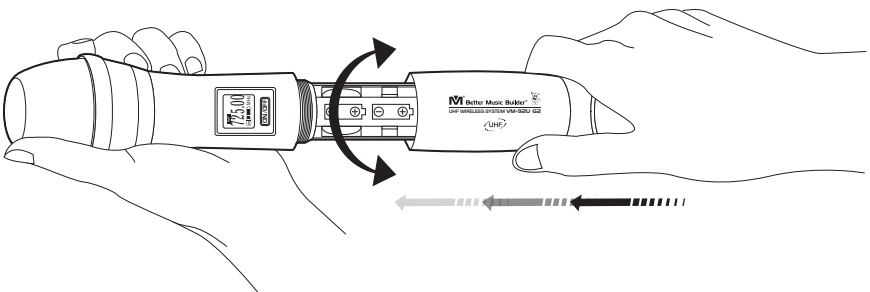

## HOW TO TURN ON/OFF MICROPHONE

**TURN ON:** Press the ON/OFF button and release it immediately to turn ON the microphone. Microphone's LCD panel will display frequency, radio frequency and battery status.

**TURN OFF:** Press and hold the power button for 3 seconds to turn OFF the microphone. Microphone's LCD panel will turn off.

After turning on the microphone's power on, there might be a need to adjust the frequency to match the receiver's frequency.

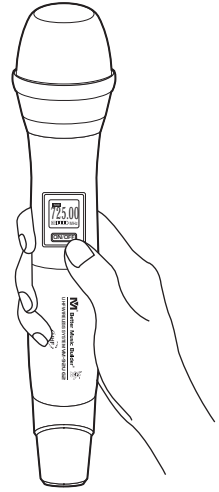

**NOTE** ▶ If the microphone cannot be turned on, please check the battery. It may be very low. Typical new full battery life is 4~6 hours with our system, otherwise, the batteries might be defective or near expiration date.

## HOW TO INTERCHANGE MICROPHONE HEAD

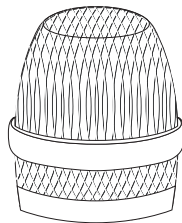
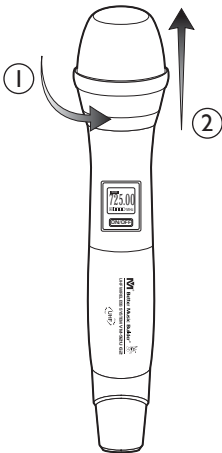

INTERCHANGEABLE  
MICROPHONE HEAD

**NOTE** ▶

Replacement parts (such as the microphone head as shown on the left) can be purchased from any of our authorized dealers.



## TECHNICAL SPECIFICATION

### A. TECHNICAL FEATURE OF THE 2-IN-1 BASE MODULE:

1. Channel: 100 Channels (total 200 Channels)
2. Frequency Range: UHF 725~750 MHz
3. Signal to Noise Ratio: > 90dB
4. Total Harmonic Distortion: < 0.5%
5. Band Width: < 250kHz
6. Frequency Response: 30Hz~19kHz +/-3dB
7. Sensitivity: >100dB
8. Effective Use Range: >50M
9. Receiver Shell: EIA standard 1/2U
10. Receiving Sensitivity: 2.0 $\mu$ V
11. Audio Output Level: Unbalanced Out: 0~+/-400mV  
Balanced Out: 0~+/-200mV
12. Power Supply: DC 14V~22V with 500mA~1000mA, AC 120V (For 220V, you may need to change to a 220V~240V DC adaptor)
13. Consume Power: 5 Watts
14. Receiver Dimensions (WxHxD): 8.2 x 1.7 x 6 (inches)/20.9 x 4.2 x 15.2(cm)
15. Package Dimensions (WxHxD): 16.9 x 13.7 x 2.8 (inches)/42.8 x 34.7 x 7.2(cm)
16. Shipping Weight: 5.6 lbs / 2.5 kg

### B. TECHNICAL FEATURE OF THE MICROPHONE:

1. Transmitter Power: 5mW or 10mW (Switchable)
2. Osillation Mode: PLL
3. Harmonic Radiation:  $\leq$ -60dBc
4. Frequency Stability:  $\pm$ 0.005%, at 0~50 $^{\circ}$ C
5. Battery Voltage: 2 x AA 1.5V Alkaline Battery
6. Continuous Using: 8 Hours (GP) 2 x AA 1.5V Battery
7. Battery Type: 1800mA/h battery
8. Microphone Dimensions (WxH): 10.2 x 2.2 (inches) / 25.8 x 5.5 (cm)

### C. THIS SYSTEM INCLUDES THE FOLLOW:

- 2-in-1 Base Module: 1 Set
- Handheld Microphone: 2 Sets
- Antenna: 2 Units
- AA 1.5V Battery: 4 Units
- DC-Power Adaptor: 1 Unit
- Audio Cable: 1 Unit
- Instructional Manual: 1 Unit





# BODY-PACK MICROPHONE SYSTEM SPECIFICATION (Optional)

## NAMES & FUNCTION:

### Body-Pack Microphone System (including Lavalier Mic. and Headset Mic.)

#### Outside Picture

1. Antenna
2. 4-pin Microphone Input Jack
3. LCD Digital Display
4. IR Port: Receives infrared beam to synchronize frequencies. IR when using multiple systems, only one microphone port should be exposed at a time
5. Battery Cover
6. Tie-Clip
7. Microphone Extension Jack

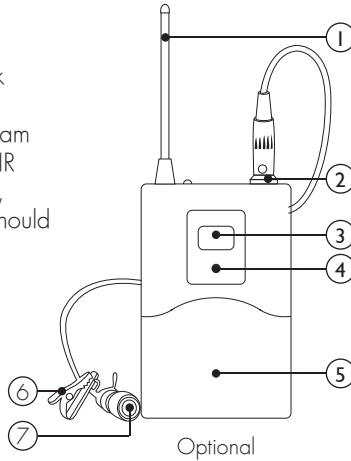

#### Side-face Picture

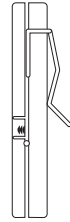

Optional

#### Inside Picture

1. Power/Mute indicator
  - Green: Ready
  - Amber: Mute Open
  - Flashing Red: IR is transmission in process
  - Glowing Red: Low battery power
  - Pulsing Red: Battery dead (microphone cannot be turned off until batteries are changed)
2. Power ON/OFF/mute switch Button: Press and hold the microphone for 3 seconds to turn power ON/OFF. Press and release to mute or un-mute the microphone.
3. Adjustment switch
4. Battery Slot

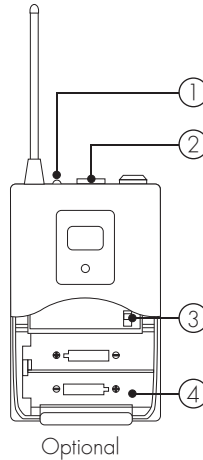

Optional

#### Lavalier Mic.

(Accessories)

1/4" to mini 3-pin lavalier cable

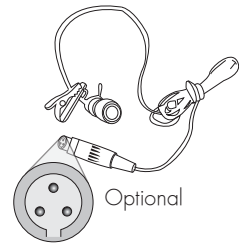

Optional

#### Headset Mic.

(Accessories)

1/4" to mini 3-pin lavalier cable



Optional

#### Apical Panel

1. Antenna Jack
2. Power/Mute indicator
3. Power Switch
4. Microphone Input Jack

Body-pack Microphone Top View

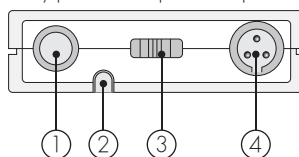

# HOW TO INSERT BODY-PACK MICROPHONE BATTERIES

**STEP 1:** Open battery cover.

**STEP 2:** Insert 2 AA alkaline batteries. 2 alkaline batteries are expected to use for about 8 hours.

Make sure that you insert batteries correctly, as shown in picture. When the microphone body-pack light glows red, the batteries should be changed immediately.

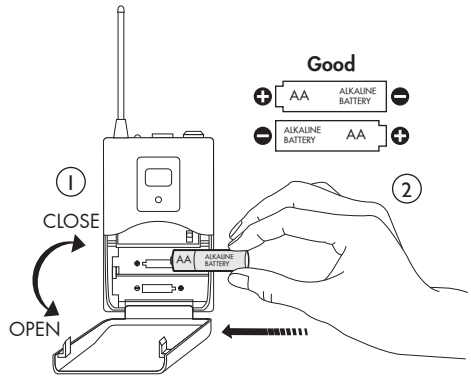

# HOW TO WEAR BODY-PACK MICROPHONE

The microphone can be buckled to the belt or the guitar band. For best result, the microphone should be pushed down until the belt is close to the base of microphone.

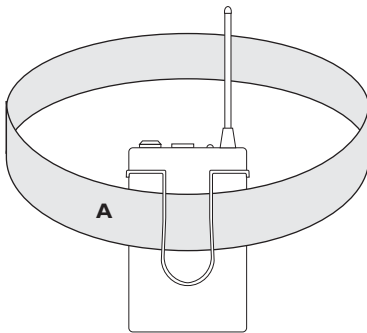

MICROPHONE BODY-PACK  
REAR VIEW

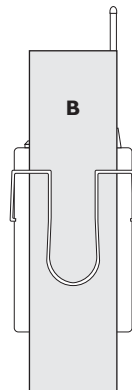

MICROPHONE BODY-PACK  
REAR VIEW

# ADJUSTMENT GAIN

Three gain settings are available. Choose the appropriate setting for your instrument.

- MIC: for the microphone adjustment
- 0: Guitar with passive pickups
- -10: Guitar with active pickups

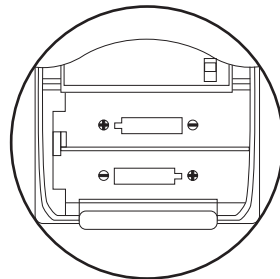



# TROUBLESHOOTING

**! CAUTION:** Before troubleshooting any symptoms make sure the equipments are in the "OFF" position.

## 1. SYMPTOM: NO SOUND COMING FROM MICROPHONE

**A. CAUSE:** There is no indication of signal.

- Turn microphone to "OFF" position. Check if batteries are inserted correctly.
- If batteries are inserted correctly, but there is no power, insert new batteries
- Make sure the microphone and receiver are in the same channel
- The volume may be turned to a low level.

**B. CAUSE:** The receiver is unpowered.

Make sure the power adapter is connected properly and there is power coming from the power outlet.

**C. CAUSE:** There is no indication of AF signal.

Turn off the receiver and make sure it is properly connected to the mixer or amplifier. If it is, slowly turn the volume higher.

**D. CAUSE:** There is no indication of RF signal.

If there is no indication of RF signal there may be interference between the receiver and the microphone. Change the channel between the microphone and receiver otherwise; Adjust the antenna of the receiver and/or move away objects between receiver and the microphone .

**2. SYMPTOM: ONE OR MORE OF THE MICROPHONE IS NOT WORKING, CHECK THE SOLUTIONS FOR CAUSES A~D ABOVE.**

## 3. SYMPTOM: RANDOM NOISE COMING OUT FROM MICROPHONE

**CAUSE:** There are interference within your area.

- Change the channel between the microphone and receiver.
- Stand further away from your speaker.

**4. SYMPTOM: THE MICROPHONE SUDDENLY HAS NO SOUND AND THE RECEIVER LCD LIGHT IS OFF.**

Make sure the AC power adapter is securely plugged into the electrical outlet and into the DC input connector on the rear panel of the receiver. Make sure the AC electrical outlet works and is supplying the proper voltage.

**5. SYMPTOM: THE MICROPHONE SUDDENLY HAS NO SOUND BUT THE RECEIVER SHOWS RF SIGNAL.**

**CAUSE:** The microphone out lead is damaged or disconnected.

To fix it, open the microphone head cover to check on the microphone out lead and re-connect the wire by welding. If it does not work, replace the microphone out lead.

**6. SYMPTOM: THE MICROPHONE DISTORTION LEVEL IS INCREASING GRADUALLY.**

**CAUSE:** The microphone batteries are running out.

Replace the microphone batteries.

**7. SYMPTOM: POOR SIGNAL**

**CAUSE:** When the 2-in-1 Base Module and microphone are placed in different rooms made of concrete wall. This would cause poor signal.

Your audio equipment is close to the police, fire or radio stations. In this case, a different frequency channel **MUST** be selected. Both the microphone and the 2-in-1 Base Module must change to a matching frequency.

**8. SYMPTOM: THE FREQUENCY OF THE MICROPHONE IS DIFFERENT FROM THE 2-in-1 Base Module.**

The microphone's frequency must match with 2-in-1 Base Module's frequency.



## APPENDIX

### VM-92U G2 FCC FREQUENCY: 725.000~774.750 MHz

#### UHF Frequencies Available for Use for Home Electronics in North America

The RF radio frequencies used in the transmission of wireless information are closely regulated in most countries including North America. A lot of countries strictly enforce their regulations stating which RF frequencies are available for use for certain device, so it can help limit the amount of radio frequency interference in all wireless communications.

Please refer to the following table for MIC 1 and MIC 2 with available RF frequencies. If the RF frequencies indicated in the following table are in conflicts with the local wireless information law in your country, please switch to a different product model or contact our technicians for advice.

#### FCC Information to User for Reference

This equipment is designed in compliance with the limits for a Class A digital device pursuant to part 15 of the FCC Rules from the United States of America. These limits are designed to provide protection against harmful interference when the equipment is operated in public environment. This equipment generates, uses, and can radiates radio frequency energy and, if not installed and used in accordance with the instruction manual, may cause harmful interference to radio communications. Operation of this equipment in a residential area may cause harmful interference, so the user will have to correct the interference at his/her own expense.

# MICROPHONE 1 FREQUENCY: 725.000~749.750 MHz

CH	FREQUENCY	CH	FREQUENCY	CH	FREQUENCY	CH	FREQUENCY
1	725.000	26	731.250	51	737.500	76	743.750
2	725.250	27	731.500	52	737.750	77	744.000
3	725.500	28	731.750	53	738.000	78	744.250
4	725.750	29	732.000	54	738.250	79	744.500
5	726.000	30	732.250	55	738.500	80	744.750
6	726.250	31	732.500	56	738.750	81	745.000
7	726.500	32	732.750	57	739.000	82	745.250
8	726.750	33	733.000	58	739.250	83	745.500
9	727.000	34	733.250	59	739.500	84	745.750
10	727.250	35	733.500	60	739.750	85	746.000
11	727.500	36	733.750	61	740.000	86	746.250
12	727.750	37	734.000	62	740.250	87	746.500
13	728.000	38	734.250	63	740.500	88	746.750
14	728.250	39	734.500	64	740.750	89	747.000
15	728.500	40	734.750	65	741.000	90	747.250
16	728.750	41	735.000	66	741.250	91	747.500
17	729.000	42	735.250	67	741.500	92	747.750
18	729.250	43	735.500	68	741.750	93	748.000
19	729.500	44	735.750	69	742.000	94	748.250
20	729.750	45	736.000	70	742.250	95	748.500
21	730.000	46	736.250	71	742.500	96	748.750
22	730.250	47	736.500	72	742.750	97	749.000
23	730.500	48	736.750	73	743.000	98	749.250
24	730.750	49	737.000	74	743.250	99	749.500
25	731.000	50	737.250	75	743.500	100	749.750

## MICROPHONE 2 FREQUENCY: 750.000~774.750 MHz

CH	FREQUENCY	CH	FREQUENCY	CH	FREQUENCY	CH	FREQUENCY
1	750.000	26	756.250	51	762.500	76	768.750
2	750.250	27	756.500	52	762.750	77	769.000
3	750.500	28	756.750	53	763.000	78	769.250
4	750.750	29	757.000	54	763.250	79	769.500
5	751.000	30	757.250	55	763.500	80	769.750
6	751.250	31	757.500	56	763.750	81	770.000
7	751.500	32	757.750	57	764.000	82	770.250
8	751.750	33	758.000	58	764.250	83	770.500
9	752.000	34	758.250	59	764.500	84	770.750
10	752.250	35	758.500	60	764.750	85	771.000
11	752.500	36	758.750	61	765.000	86	771.250
12	752.750	37	759.000	62	765.250	87	771.500
13	753.000	38	759.250	63	765.500	88	771.750
14	753.250	39	759.500	64	765.750	89	772.000
15	753.500	40	759.750	65	766.000	90	772.250
16	753.750	41	760.000	66	766.250	91	772.500
17	754.000	42	760.250	67	766.500	92	772.750
18	754.250	43	760.500	68	766.750	93	773.000
19	754.500	44	760.750	69	767.000	94	773.250
20	754.750	45	761.000	70	767.250	95	773.500
21	755.000	46	761.250	71	767.500	96	773.750
22	755.250	47	761.500	72	767.750	97	774.000
23	755.500	48	761.750	73	768.000	98	774.250
24	755.750	49	762.000	74	768.250	99	774.500
25	756.000	50	762.250	75	768.500	100	774.750



## WARRANTY

### One-Year Limited Warranty for Home Use Equipment

Our one-year warranty applies to speakers, amplifiers, mixers and microphones for home use only. It covers both parts and labors. The warranty becomes effective on the date of your purchase.

Our warranty only covers defects due to product defectiveness with free of defects in materials or workmanship. However, our warranty does not cover defects due to normal wears, damage in transit, improper use, abuse or failure to follow the proper instructions for maintenance. This warranty is void in the event of unauthorized repairs, alternations, modifications and removing of the product label.

Please also note that our warranty does not cover any shipping cost for the return of defective products to us for inspection, repair and maintenance. Our warranty for Better Music Builder products can only be executed in North America.

**NOTE** ► Our warranty does not cover the battery for wireless microphone products.

### 90-Day Limited Warranty for Public and Commercial Use Equipment

Our 90-day warranty applies to speakers, amplifiers, mixers and microphones for both public and commercial use such as restaurant, coffee shop, KTV nightclub, church and school, etc. It covers both parts and labors. The warranty becomes effective on the date of your purchase.

### To Register Your Warranty

Please submit the warranty card that comes with your unit; it is also download on our website . However, we need the invoice for your purchase in order to process this warranty. You may also register your warranty online.

Please visit our website at [www.BetterMusicBuilder.com](http://www.BetterMusicBuilder.com).

## PRECAUTION

1. If using more than one microphone system, please select the operating frequency or signal channel carefully so as to avoid disturbing.
2. The input power voltage of the 2-in-1 Base Module is 110V/120V ( $\pm 10\%$ ). If it is too low or too high, it will affect the work of the machine.
3. When installing batteries, reversing the electrode will damage the machine.



**Caution:** To reduce the risk of electrical shock, do not remove the cover (or back). No user serviceable parts inside: refer servicing to qualified personnel.

**Warning:** To reduce the risk of fire or electrical shock, do not expose this appliance to rain or moisture.



This symbol, wherever it appears, alerts you to the presence of uninsulated dangerous voltage inside the enclosure voltage that may be sufficient to constitute a risk of shock.



This symbol, wherever it appears, alerts you to important operating and maintenance instructions in the accompanying literature. Read the manual.





## CONTACT INFORMATION

### MAILING ADDRESS



BETTER MUSIC BUILDER  
29300 Kohoutek Way #150  
Union City, CA 94587  
U.S.A.

### TELEPHONE NUMBERS



USA Region  
USA Toll Free: 1-800-318-2218  
Sales & Marketing: 510-477-9955  
Customer Service: 510-477-9955

### FAX NUMBERS



USA Region  
Sales & Marketing: 510-477-9922  
Customer Service: 510-477-9922

### WORLD WIDE WEB



E-mail: [sales@bettermusicbuilder.com](mailto:sales@bettermusicbuilder.com)  
Website: [www.bettermusicbuilder.com](http://www.bettermusicbuilder.com)





Better Music Builder® is a leader in the Audio and Karaoke equipment industry. We are committed to offering you high quality audio products. Unlike any others brand, we deliver the best cost and value to you directly. For the latest update information including operation manuals, installation instructions, hook-up diagram and other new technologies updates etc. please visit us at our website [www.BetterMusicBuilder.com](http://www.BetterMusicBuilder.com).



*Passionate about Music*  
**[www.BetterMusicBuilder.com](http://www.BetterMusicBuilder.com)**



Code: 20130921