



Unlike any others ... that's cost & value for you

Professional UHF Wireless Microphone System

VM-82U G3

Operating Instructions

G3 SERIES Generation 3



2-in-1 Base Module ***1 Receive Module with 2 Wireless Microphones System

Thank you for purchasing this unit. To make full and effective use of this unit, please read this Owner's Manual carefully before operating it. Please retain this manual for future reference.

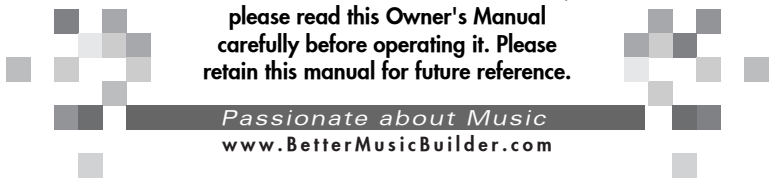

CONTENTS



INTRODUCTION..... 1



SYSTEM FEATURES..... 1



PACKAGE ACCESSORIES..... 2



2-in-1 BASE MODULE..... 3

- Controls and Functions..... 3~4
- Hardware Setup..... 5~6



HAND-HELD MICROPHONE..... 7

- Controls and Functions..... 7~8



OPERATION..... 9

- How to Set Up Microphone Frequency..... 9
- How to Lock/unlock Receiver's Settings..... 10
- How to Adjust Microphone Volume..... 11
- How to Adjust Squelch..... 11
- How to Insert/change Batteries of Microphone..... 12
- How to Turn On/Off Microphone..... 13
- How to Interchange Microphone Head..... 13



TECHNICAL SPECIFICATION..... 14



BODY-PACK MICROPHONE (Optional)..... 15~16



TROUBLESHOOTING..... 17~18



APPENDIX..... 19~20



WARRANTY..... 21



CONTACT INFORMATION..... 22



INTRODUCTION

Better Music Builder VM-82U G3 is a third generation wireless microphone that uses the latest UHF wireless technology. It is the most advanced and customizable wireless microphone system we have to offer. Its sleek design features heavy duty UHF dual-channel microphones, built-in LCD panels, Wireless Infrared Auto Sync System, 30 unique channels for each microphone, and ultra long battery life.

Don't make setting up harder on you! Use the Wireless Infrared Auto Sync System for a hassle-free setup. Say good bye to having to adjust the microphone's frequency. With a touch a button, the microphone automatically synchronizes with the receiver to create a complete interference free and crystal clear microphone system. The VM-82U G3 Wireless Microphone also features the ability to lock on to your personal favorite settings.

Clear Voice delivers crystal clearer sound quality that pro audio engineers trust. It automatically enhances the sound of the vocal by detecting and eliminating artifact noises. The result is a sound closer resembles that of a wired microphone. What you get is a cleaner and clearer sound at all audio levels.

Better Music Builder is committed in always seeking new ways to make our products better. We are well aware of short battery life among your favorite microphone systems. Through intensive research we have developed a better power management system to give our VM-82U G3 a much needed boost in battery life.

It is simply the best solution for home and professional karaoke performance



SYSTEM FEATURES

1. Equipped with the latest UHF wireless technology and dual-channel in a 2-in-1 Base Module to prevent signal interference.
2. Clear LCD panel displaying Radio Frequency (RF), Audio Frequency (DEV), Sync, Mute, Lock, Battery, Frequency, Channel, Squelch, and Antenna status.
3. Wireless Infrared Auto Sync System saves you time setting up.
4. Clear Voice technology delivers crystal clearer sound just like a wired microphone.
5. 60 unique selectable channels!
6. Ability to lock on personal favorite settings.
7. Adjustable antennas for better signal receiving.
8. Up to 8 hours of battery life.



PACKAGE ACCESSORIES

The package comes with one 2-in-1 Base Module [Receiver], two handheld microphones, two antennas, one DC adaptor, one unbalanced audio cable, and four AA batteries.

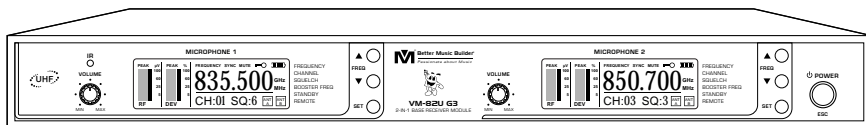

2-IN-1 BASE MODULE [RECEIVER]: 1 SET

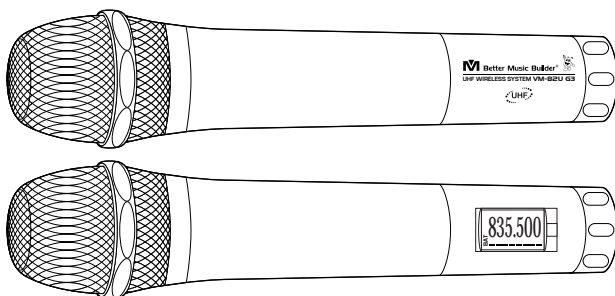

HANDHELD MICROPHONE: SET of 2

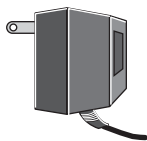

DC POWER ADAPTOR: 1 UNIT

NOTE DC-POWER USAGE: This wireless microphone system is designed specifically for the North American market, which use 110V for DC power. If you use this system in Asia or Europe, you need to change it to 220V by an adaptor with DC-14V output 500mA.

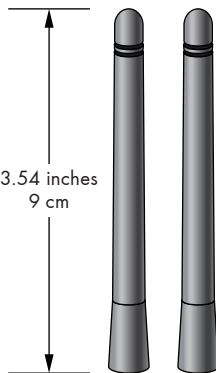

RECEIVING ANTENNA: 2 UNITS

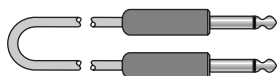

AUDIO CABLE (FOR MIXED OUT): 1 UNIT



For better quality connections, a XLR to XLR cable is highly recommended.

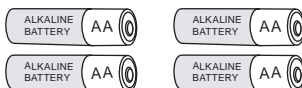

AA (1.5V) BATTERY: 4 UNITS



2-in-1 BASE MODULE [RECEIVER]

CONTROLS AND FUNCTIONS

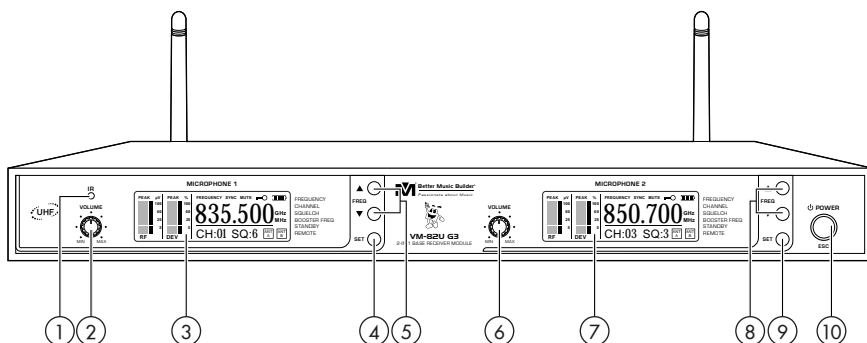

FRONT PANEL:

1. IR PORT: Broadcasts signal to microphone to allow communication.
2. MIC 1 VOLUME: Controls audio output level.
3. MIC 1 LCD PANEL: Displays system status.
4. MIC 1 SET: Synchronizes frequencies between receiver and microphone.
5. MIC 1 UP“▲”/DOWN“▼” : Selects frequency and squelch.
6. MIC 2 VOLUME: Controls audio output level.
7. MIC 2 LCD PANEL: Displays system status.
8. MIC 2 UP“▲”/DOWN“▼” : Selects frequency and squelch.
9. MIC 2 SET: Synchronizes frequencies between receiver and microphone.
10. POWER: Turns system On/Off.

LCD PANEL:

After turning on the “POWER” button, LCD screen will display the following:

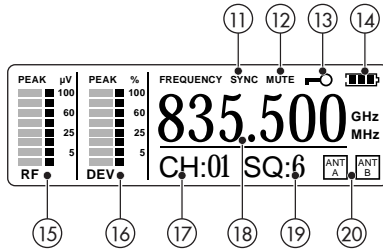

11. SYNC: Shows that synchronization is in progress.
12. MUTE: Shows that microphone is not set up or Off.
13. LOCK/UNLOCK: Shows whether current settings are locked.
14. BATTERY STATUS: Shows battery level of microphone.
15. RF (Radio Frequency): Shows strength indicator of radio signal.
16. DEV (Audio Frequency): Shows strength indicator of incoming audio signal.
17. CHANNEL: Shows current channel.
18. FREQUENCY: Shows current frequency.
19. SQUELCH: Shows coverage range of microphone. The disadvantage of using a longer range is the increased chance of interference.
20. ANTENNA A/B: Shows the antenna in use. When one antenna experiences noise or interference, the other antenna takes over.

REAR PANEL:

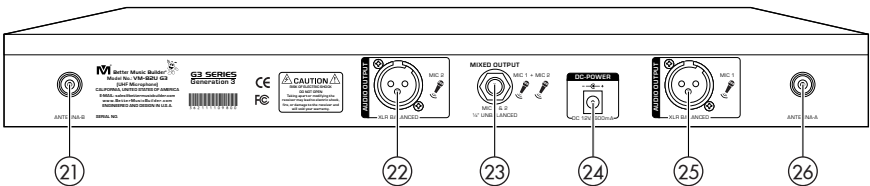

21. ANTENNA-B: Connect antenna to BNC socket here.
22. MIC 2 BALANCED OUTPUT: XLR balanced audio output.
23. MIC 1 & MIC 2 MIXED OUTPUT: Unbalanced ¼ inch audio output.
24. POWER SUPPLY: Removable adapter with DC 12V 600mA.
25. MIC 1 BALANCED OUTPUT: XLR balanced audio output.
26. ANTENNA-A: Connect antenna to BNC socket here.



HARDWARE SETUP

HOW TO CONNECT AUDIO OUTPUT:

There are three rear outputs as shown in the below diagram:

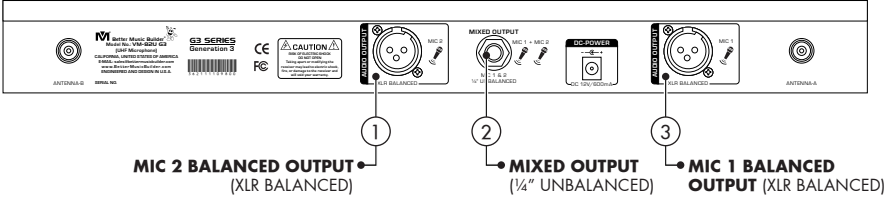

1. MIC 2 BALANCED OUTPUT is balanced audio output using XLR connection. The grounding of the balanced XLR connection delivers better quality signal and reduces unwanted noise. This output enables adjusting MIC 2 effects independently without affecting MIC 1 effects.

2. MIC 1 & MIC 2 MIXED UNBALANCED OUTPUT is unbalanced audio output using 1/4" connection. In effect, two channels are sharing one single signal. To produce different effects on each microphone, MIC 1 and MIC 2 need their own independent signals by using two separate XLR connections.

3. MIC 1 BALANCED OUTPUT is balanced audio output using XLR connection. The grounding of the balanced XLR connection delivers better quality signal and reduces unwanted noise. This output enables adjusting MIC 1 effects independently without affecting MIC 2 effects.



We highly recommend using balanced XLR connections if the distance between the microphone receiver and the amplifier/mixer is more than 10 feet. The grounding of the balanced XLR connection delivers better quality signal and reduces unwanted noise.

UHF WIRELESS SYSTEM DIAGRAM:

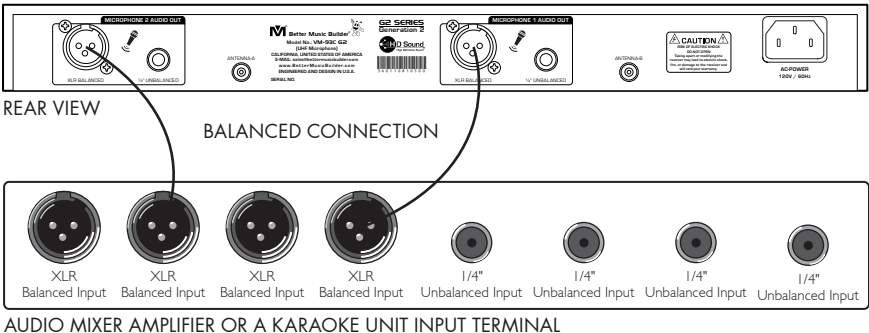
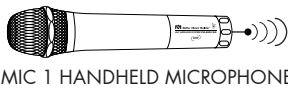

HOW TO CONNECT DC-POWER:

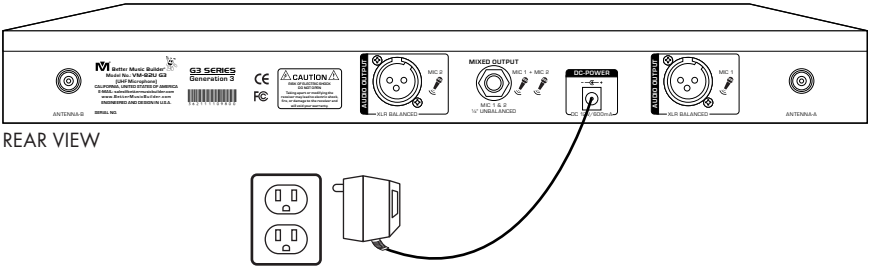

For North America Market, use 120V, DC 12V 600mA adaptor. For market outside North America, use 220V~ 240V DC adaptor with a maximum battery capacity of 600mA.

NOTE Please make sure to use the right DC adaptor. Otherwise, it may damage the 2-in-1 Base Module because the maximum battery capacity is different. The product warranty will be void if there is damage caused by using the wrong DC adaptor.

OPTIONAL 19" RACK MOUNT KIT:

To put the system onto a mount-kit, please follow the diagram below. Our special design feature allows it to be mounted on a DJ rack.

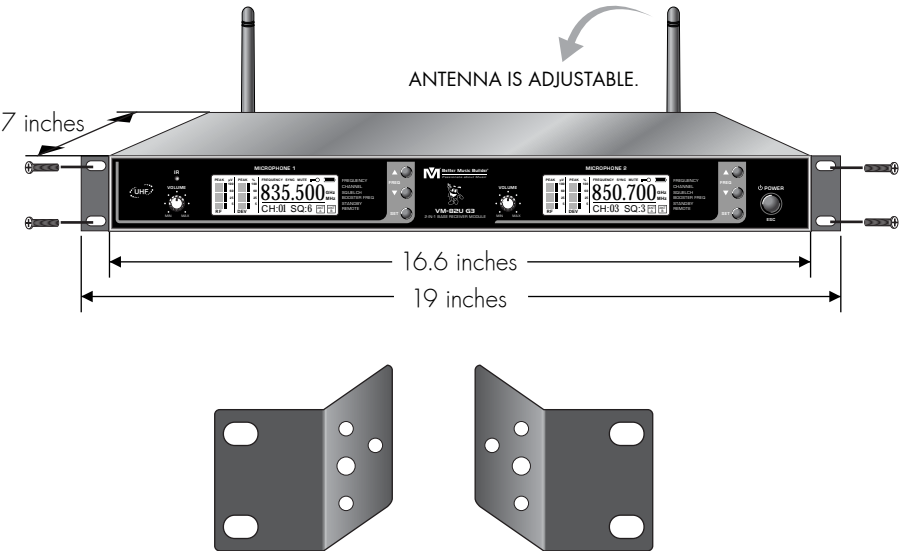

RACK MOUNT KIT IS NOT INCLUDED.



HANDHELD MICROPHONE

CONTROLS AND FUNCTIONS

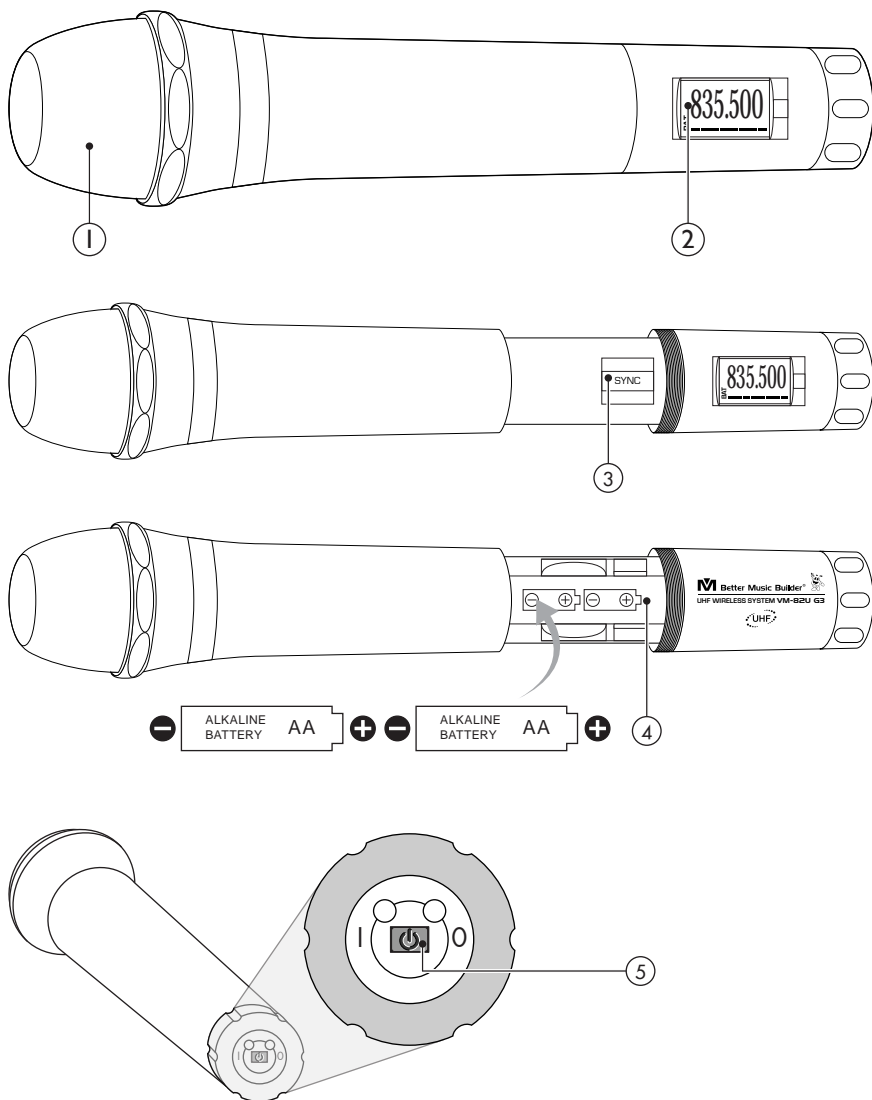

1. INTERCHANGEABLE MICROPHONE HEAD
2. LCD PANEL: Displays system status.
3. IR PORT: Broadcasts signal to receiver to allow communication.
4. BATTERY COMPARTMENT: Insert two AA batteries.
5. POWER: Turns microphone On/Off.

LCD PANEL:

After turning on the "POWER", the LCD panel will light up as below:

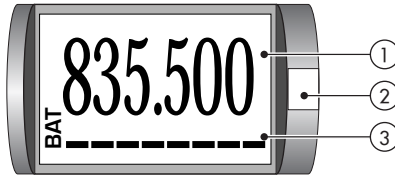

1. **FREQUENCY:** Shows current frequency.
2. **LED (BATTERY POWER INDICATOR):** If green light is on, indicates battery power is at normal status. If red light is flashing, indicates low battery. No light means power off or no power.
3. **BATTERY STATUS:** Shows battery level of microphone.

BATTERY STATUS:

Full Battery

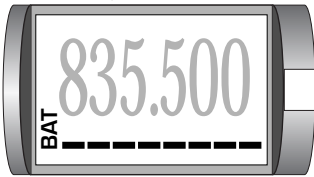

Indicates full battery on the microphone. The engineering team of Better Music Builder uses the latest technology to indicate the battery status, so you can see the battery strength.

Low Battery

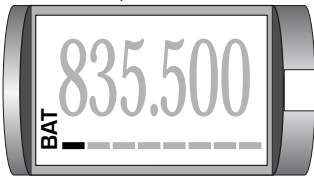

Indicates low battery on the microphone. When the microphone LCD panel is blinking or fading, its time to replace the batteries.

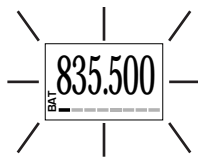

LCD panel will blink constantly when battery is extremely low and about to die.

NOTE If the microphone cannot be turn on, please check the battery. It may be very low. Typical new full battery life is 8 hours with our system, otherwise, the batteries might be defective or near expiration date.

Batteries are not covered under our product warranty.



OPERATION

HOW TO SET UP MICROPHONE FREQUENCY

Setting up the microphone is quick and easy. Please follow these simple steps:

STEP 1: Press UP “▲”/DOWN “▼” on the receiver to select desired frequency.

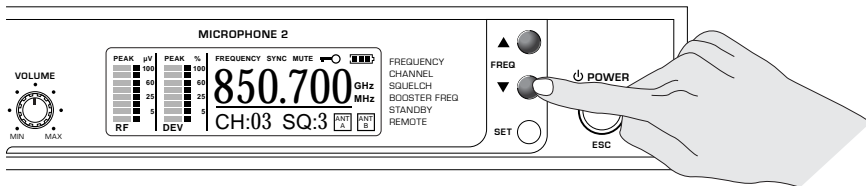

STEP 2: Open battery compartment on the microphone. Point MIC’s IR PORT directly at the receiver’s IR PORT that is located on the upper-left-hand corner.

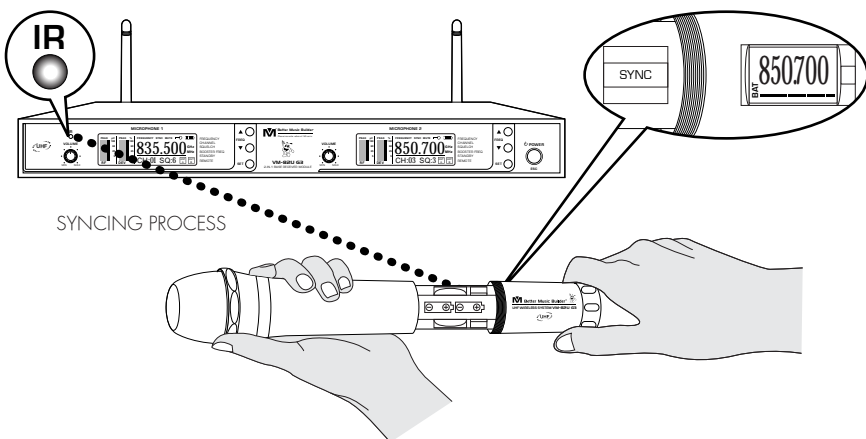

STEP 3: Press SET to initiate the synchronization process. The IR PORT will show red light if it is sync correctly.

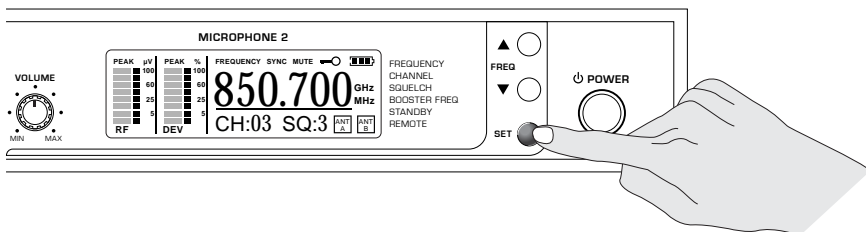

NOTE Each unit is fully tested and qualified by the manufacturer. However, due to the nature of wireless connection, interference may occur because of local environments and/or radio signals emitted by other wireless devices within the household.

If MIC 1 or MIC 2 is actively picking up RADIO FREQUENCY (RF) signal when the microphone is turned off, this is an indication that the frequency is being used by some other active device within a 200 feet radius. Therefore, selecting a different frequency is highly recommended.

HOW TO LOCK/UNLOCK RECEIVER'S SETTINGS

Do the following when the receiver is POWERED OFF.

STEP 1: Press and hold SET on the receiver. Do not release it.

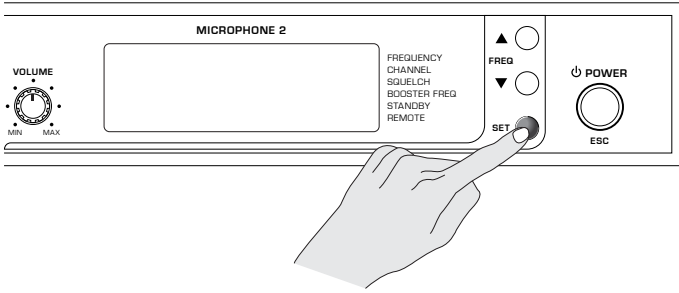

STEP 2: Then Press POWER on the receiver.

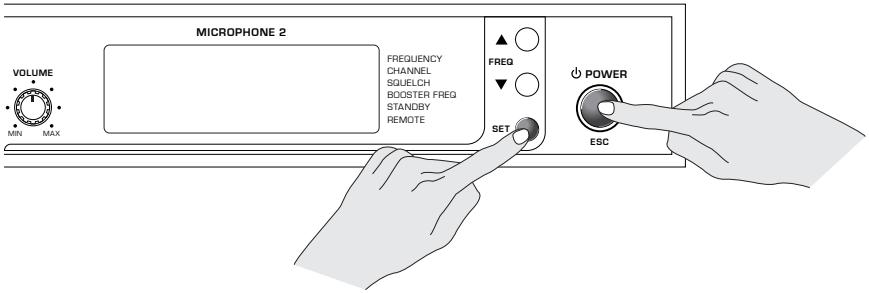

STEP 3: After the receiver is on, release both buttons to LOCK/UNLOCK settings.

The LCD panel will show as below:

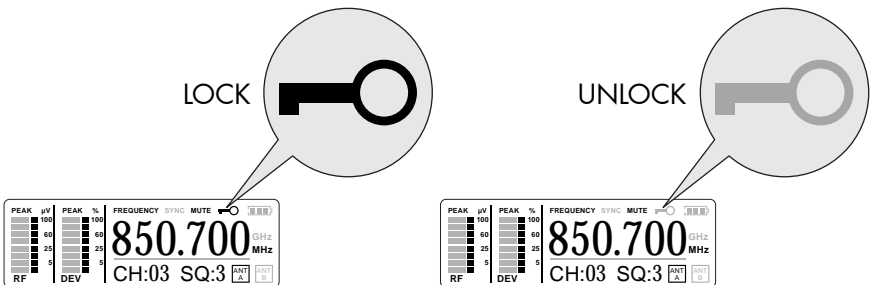



NOTE While the settings are locked, the frequency and the squelch level cannot be changed.

HOW TO ADJUST MICROPHONE VOLUME

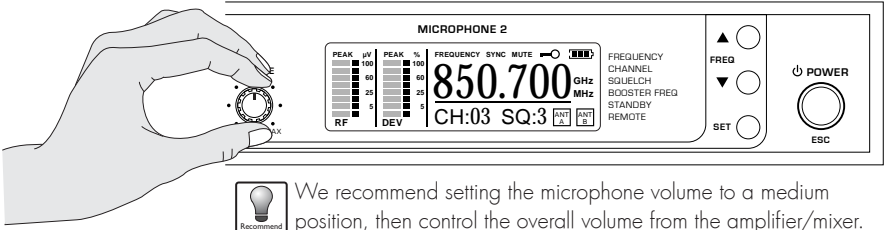
Turn VOLUME left to decrease the volume and right to increase the volume on the receiver.



 We recommend setting the microphone volume to a medium position, then control the overall volume from the amplifier/mixer.

 If the user does any damage to the receiver either accidentally or intentionally, we have the right to void the warranty.

HOW TO ADJUST SQUELCH

STEP 1: Press and hold SET on the receiver. Do not release it.

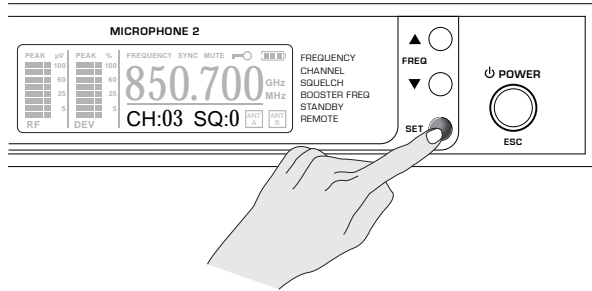

STEP 2: Press UP "▲"/DOWN "▼" on the receiver to select the desired squelch level.

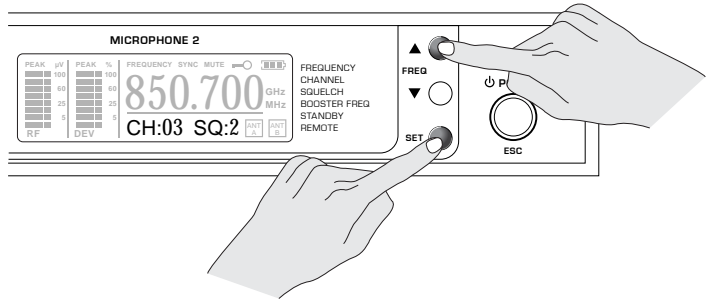

STEP 3: Release both buttons to set the squelch level.

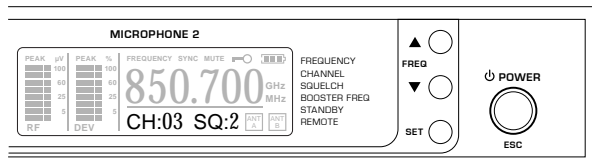

NOTE → SQUELCH (SQ) is used to avoid reproducing noise when the microphone does not receive enough signals. A value of 0 turns the squelch level off, resulting in more noise and interference. In contrast, a value of 9 turns the squelch level to the maximum, providing the most anti-interference ability. However, the drawback of using a higher level of squelch is the reduced range of the microphone.

HOW TO INSERT/CHANGE BATTERIES OF MICROPHONE

STEP 1: Twist and slide open the battery cover.

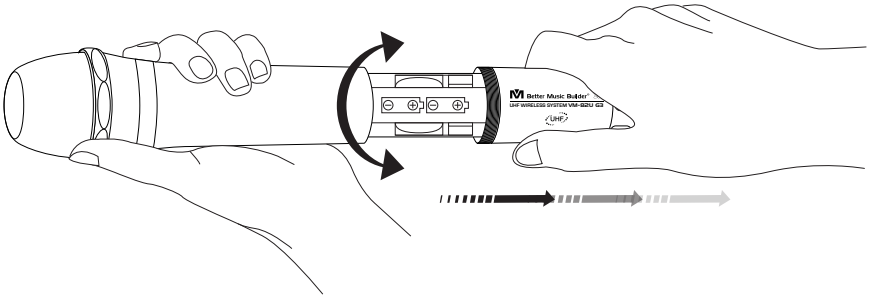

STEP 2: Hold the top of the microphone with one hand and with the other hand slide two AA batteries into the battery compartment.

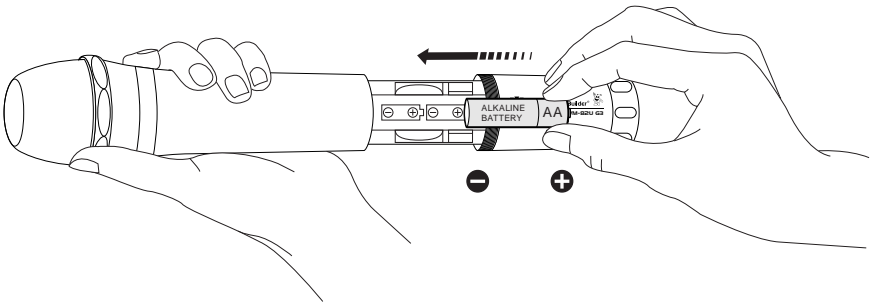

 Be careful not to drop the microphone while inserting batteries and to follow the polarity of the battery according to the diagram.

Good



No Good



STEP 3: Slide and twist back the battery cover.

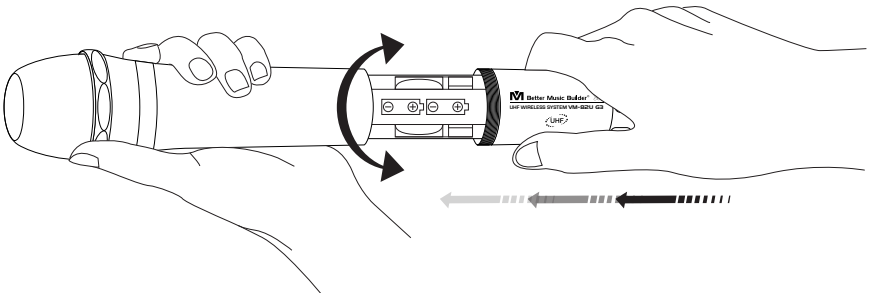

HOW TO TURN ON/OFF MICROPHONE

TURN ON: Press the power button and release it immediately to turn ON the microphone. Microphone's LCD panel will display frequency, and battery status.

TURN OFF: Press and hold the power button for 3 seconds to turn OFF the microphone. Microphone's LCD panel will turn off.

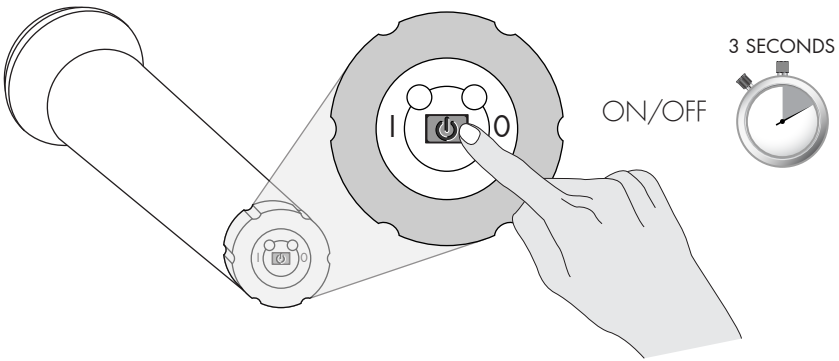

NOTE If the microphone cannot be powered ON, battery may be low and should be replaced. Typical battery life is up to 8 hours. Battery life may vary depending on usage.

HOW TO INTERCHANGE MICROPHONE HEAD

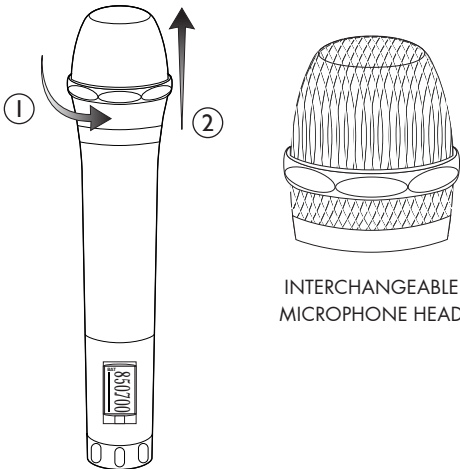

NOTE Replacement parts such as the INTERCHANGEABLE MICROPHONE HEAD can be purchased from any of our authorized dealers.



TECHNICAL SPECIFICATION

A. TECHNICAL FEATURE OF THE 2-IN-1 BASE MODULE:

1. Frequency Range: UHF 820~990 MHz
2. Channels: 60
3. Signal to Noise Ratio: > 90dB
4. Total Harmonic Distortion: $\leq 1\%$
5. Frequency Response: 80Hz ~ 15KHz (± 3 dB)
6. Spurious Emission: ≥ 75 dB
7. Receiver Sensitivity: 80dB (12dBuV)
8. Audio Output Level: Balanced Out: 0~0.5V/600MA
Unbalanced Out: 0~0.5V/5K
9. Power Supply: 12~16V DC
10. Current: 300mA
11. Effective Distance: 100 feet
12. Operating Temperature: $-20^{\circ}\text{C} \sim 40^{\circ}\text{C}$
13. Receiver Dimensions (WxHxD): 16.5 x 1.8 x 7.5 (in)/42 x 4.5 x 19 (cm)
14. Package Dimensions (WxHxD): 21.7 x 15.9 x 2.6 (in)/55 x 40.3 x 6.5 (cm)
15. Shipping Weight: 8.6 lbs / 3.9 kg

B. TECHNICAL FEATURE OF THE MICROPHONE:

1. Transmitter Power: ≤ 20 mV
2. Max Deviation: ± 45 kHz
3. Spurious Emission: -50dB
4. Battery: 2 x AA 1.5V Alkaline Batteries
5. Continuous Usage: Up to 8 Hours
6. Microphone Dimensions (WxH): 9.5 x 2.1 (inches) / 24 x 5.4 (cm)

C. THIS SYSTEM INCLUDES THE FOLLOW:

- 2-in-1 Base Module (receiver): 1 Set
- Handheld Microphone: Set of 2
- DC-Power Adaptor: 1 Unit
- Audio Cable: 1 Unit
- Antenna: 2 Units
- AA 1.5V Battery: 4 Units
- Instructional Manual: 1 Unit



BODY-PACK MICROPHONE SYSTEM SPECIFICATION (Optional)

NAMES & FUNCTION:

Body-Pack Microphone System (including Lavalier Mic. and Headset Mic.)

Outside Picture

1. Antenna
2. 4-pin Microphone Input Jack
3. LCD Digital Display
4. IR Port: Receives infrared beam to synchronize frequencies. IR when using multiple systems, only one microphone port should be exposed at a time
5. Battery Cover
6. Tie-Clip
7. Microphone Extension Jack

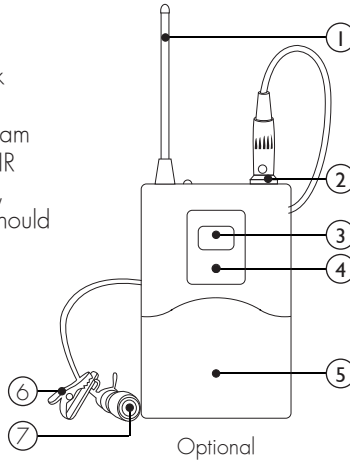

Side-face Picture

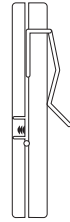

Optional

Inside Picture

1. Power/Mute indicator
 - Green: Ready
 - Amber: Mute Open
 - Flashing Red: IR is transmission in process
 - Glowing Red: Low battery power
 - Pulsing Red: Battery dead (microphone cannot be turned off until batteries are changed)
2. Power ON/OFF/mute switch Button: Press and hold the microphone for 3 seconds to turn power ON/OFF. Press and release to mute or un-mute the microphone.
3. Adjustment switch
4. Battery Slot

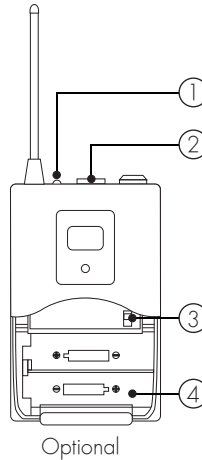

Optional

Lavalier Mic.

(Accessories)

1/4" to mini 3-pin lavalier cable

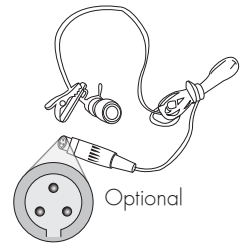

Optional

Headset Mic.

(Accessories)

1/4" to mini 3-pin lavalier cable

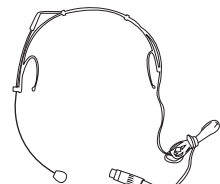

Optional

Apical Panel

1. Antenna Jack
2. Power/Mute indicator
3. Power Switch
4. Microphone Input Jack

Body-pack Microphone Top View

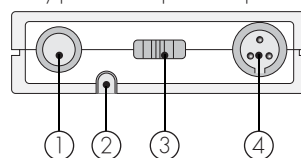

HOW TO INSERT BODY-PACK MICROPHONE BATTERIES

STEP 1: Open battery cover.

STEP 2: Insert 2 AA alkaline batteries. 2 alkaline batteries are expected to use for about 8 hours.

Make sure that you insert batteries correctly, as shown in picture. When the microphone body-pack light glows red, the batteries should be changed immediately.

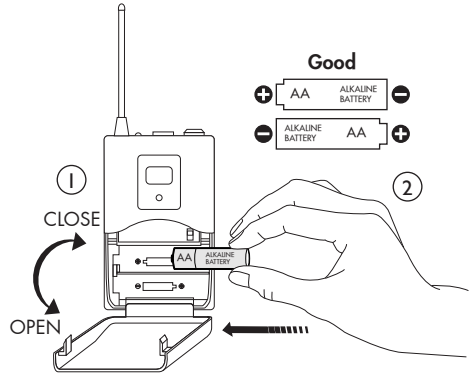

HOW TO WEAR BODY-PACK MICROPHONE

The microphone can be buckled to the belt or the guitar band. For best result, the microphone should be pushed down until the belt is close to the base of microphone.

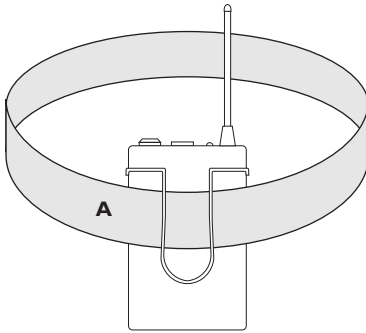

MICROPHONE BODY-PACK
REAR VIEW

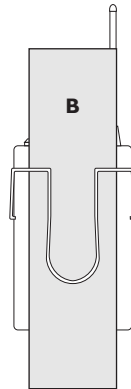

MICROPHONE BODY-PACK
REAR VIEW

ADJUSTMENT GAIN

Three gain settings are available. Choose the appropriate setting for your instrument.

- MIC: for the microphone adjustment
- 0: Guitar with passive pickups
- -10: Guitar with active pickups

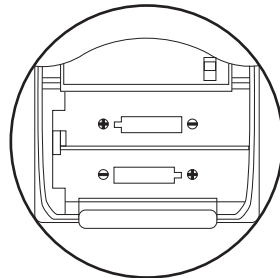



TROUBLESHOOTING



CAUTION: Before troubleshooting any symptoms, make sure equipments are turned OFF.

1. SYMPTOM: NO SOUND COMING FROM MICROPHONE

CAUSE: There is no indication of signal.

REMEDIES:

- A. Battery may be low and should be recharged by placing the microphone onto the CHARGER BASE.
- B. Microphone and receiver should be in the same channel to allow transmitting and receiving signal.
- C. Volume is turned to a low level and should be turned to a high but comfortable volume level.
- D. Make sure no wires inside the microphone are loose. If so, reconnect wires if possible.
- E. Make sure the microphone is turned ON; not OFF.

2. SYMPTOM: RECEIVER LCD IS OFF.

CAUSE: Receiver is unpowered.

REMEDIES:

- A. AC POWER CORD should be connected properly.
- B. Make sure the right AC POWER CORD is being used.
- C. Determine whether there is indeed current coming from the power outlet.

3. SYMPTOM: NOISES.

CAUSE: There is interference within your area.

REMEDIES:

- A. Make sure user is not standing too close to speakers. Microphone being too close to speakers will create feedback unless microphone volume is turned down.
- B. Audio cable of poor quality should not be used. Switching to a cable of higher quality such as a balanced XLR cable can reduce noise.
- C. Switch to a model that uses a different set of channels when the above remedies do not work.

4. SYMPTOM: DISTORTION IS INCREASING GRADUALLY.

CAUSE: Battery is running low.

REMEDIES:

- A. Recharge battery as soon as possible.
- B. Make sure to fully charge battery before use.

5. SYMPTOM: POOR SIGNAL.

CAUSE: Objects can be disrupting communication between receiver and microphone.

REMEDIES:

- A. Make sure no objects are between receiver and microphone, such as walls and shelves.
- B. Make sure microphone usage is not in perimeter of police, fire or radio stations.
- C. Devices that send out radio signals can be disruptive, such as cell phones, radios, computers, etc.
- D. Switch to a model that uses a different set of channels when the above remedies do not work.



APPENDIX

VM-82U G3 FCC FREQUENCY: 820.000~990.000 MHz

UHF Frequencies Available for Use for Home Electronics in North America

The RF radio frequencies used in the transmission of wireless information are closely regulated in most countries including North America. A lot of countries strictly enforce their regulations stating which RF frequencies are available for use for certain device, so it can help limit the amount of radio frequency interference in all wireless communications.

Please refer to the following table for MIC 1 and MIC 2 with available RF frequencies. If the RF frequencies indicated in the following table are in conflicts with the local wireless information law in your country, please switch to a different product model or contact our technicians for advice.

FCC Information to User for Reference

This equipment is designed in compliance with the limits for a Class A digital device pursuant to part 15 of the FCC Rules from the United States of America. These limits are designed to provide protection against harmful interference when the equipment is operated in public environment. This equipment generates, uses, and can radiates radio frequency energy and, if not installed and used in accordance with the instruction manual, may cause harmful interference to radio communications. Operation of this equipment in a residential area may cause harmful interference, so the user will have to correct the interference at his/her own expense.

MIC 1 & MIC 2 FREQUENCY: 820.000~990.000 MHz

MIC 1 FREQUENCY 835~850MHz				MIC 2 FREQUENCY 850~865MHz			
CH	FREQUENCY	CH	FREQUENCY	CH	FREQUENCY	CH	FREQUENCY
1	835.500	16	842.525	1	849.950	16	857.300
2	836.300	17	842.850	2	850.425	17	857.875
3	836.650	18	843.450	3	850.700	18	858.225
4	837.250	19	843.825	4	8511.00	19	858.650
5	837.700	20	844.300	5	851.500	20	859.100
6	838.250	21	844.800	6	852.225	21	859.500
7	838.475	22	845.100	7	852.725	22	859.950
8	838.850	23	845.900	8	853.200	23	860.350
9	839.300	24	846.500	9	853.900	24	860.750
10	839.800	25	847.300	10	854.300	25	861.000
11	840.175	26	847.750	11	854.900	26	861.650
12	840.525	27	848.225	12	855.275	27	863.125
13	840.850	28	848.750	13	855.750	28	863.500
14	841.200	29	849.300	14	856.175	29	864.100
15	841.825	30	849.650	15	856.725	30	864.900



WARRANTY

One-Year Limited Warranty for Home Use Equipment

Our one-year warranty applies to speakers, amplifiers, mixers and microphones for home use only. It covers both parts and labors. The warranty becomes effective on the date of your purchase.

Our warranty only covers defects due to product defectiveness with free of defects in materials or workmanship. However, our warranty does not cover defects due to normal wears, damage in transit, improper use, abuse or failure to follow the proper instructions for maintenance. This warranty is void in the event of unauthorized repairs, alternations, modifications and removing of the product label.

Please also note that our warranty does not cover any shipping cost for the return of defective products to us for inspection, repair and maintenance. Our warranty for Better Music Builder products can only be executed in North America.

NOTE ► Our warranty does not cover the battery for wireless microphone products.

90-Day Limited Warranty for Public and Commercial Use Equipment

Our 90-day warranty applies to speakers, amplifiers, mixers and microphones for both public and commercial use such as restaurant, coffee shop, KTV nightclub, church and school, etc. It covers both parts and labors. The warranty becomes effective on the date of your purchase.

To Register Your Warranty

Please submit the warranty card that comes with your unit; it is also download on our website . However, we need the invoice for your purchase in order to process this warranty. You may also register your warranty online.

Please visit our website at www.BetterMusicBuilder.com.

PRECAUTION

1. If using more than one microphone system, please select the operating frequency or signal channel carefully so as to avoid disturbing.
2. The input power voltage of the 2-in-1 Base Module is 110V/120V ($\pm 10\%$). If it is too low or too high, it will affect the work of the machine.
3. When installing batteries, reversing the electrode will damage the machine.



Caution: To reduce the risk of electrical shock, do not remove the cover (or back). No user serviceable parts inside: refer servicing to qualified personnel.

Warning: To reduce the risk of fire or electrical shock, do not expose this appliance to rain or moisture.



This symbol, wherever it appears, alerts you to the presence of uninsulated dangerous voltage inside the enclosure voltage that may be sufficient to constitute a risk of shock.



This symbol, wherever it appears, alerts you to important operating and maintenance instructions in the accompanying literature. Read the manual.



CONTACT INFORMATION

MAILING ADDRESS



BETTER MUSIC BUILDER
29300 Kohoutek Way #150
Union City, CA 94587
U.S.A.

TELEPHONE NUMBERS



USA Region
USA Toll Free: 1-800-318-2218
Sales & Marketing: 510-477-9955
Customer Service: 510-477-9955

FAX NUMBERS



USA Region
Sales & Marketing: 510-477-9922
Customer Service: 510-477-9922

WORLD WIDE WEB



E-mail: sales@bettermusicbuilder.com
Website: www.bettermusicbuilder.com

Better Music Builder is a leader in the Audio and Karaoke equipment industry. We are committed to offering you high quality audio products. We may update our manual, so we highly recommend you to download the free update from our website at www.BetterMusicBuilder.com.



Passionate about Music
www.BetterMusicBuilder.com



Code: 20111122